

MAGB1

First Installation Guide



Arkon Flow Systems

Nováčkova 11, 614 00 Brno, Czech Republic

Tel. +420 543 214 822, Tel./Fax +420 543 215 249

Enquiries/ Orders/ General questions: office@arkon.co.uk

Marketing support/ Brochures: marketing@arkon.co.uk

Technical support: support@arkon.co.uk

www.arkon.co.uk

1 SENSOR SOAKING

Flowmeters can show unstable readings during the first 2-3 days after installation. This change, in effect, affects reading accuracy. Simply by keeping the meter wet, this problem solves itself within 2-3 days and no other action is required at all.

Soaking of the sensor under operational conditions with a wetted full pipe



Nuts and bolts must be tightened correctly

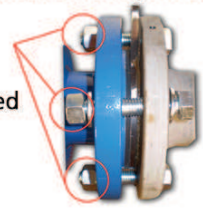

2 SENSOR INSTALLATION

Electromagnetic flowmeters only work correctly under certain determined conditions. For our right to guarantee the product, all those conditions have to be met in all applications. Those conditions are achieved by the correct installation of the sensor.

Flowmeter sensor must always remain full of liquid.

For horizontal mounting locate the sensor in a low section of the pipe.



For vertical mounting flow direction must be upwards.

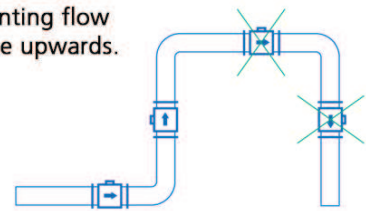

For installations with pumps, never install the sensor on the suction side of the pump.

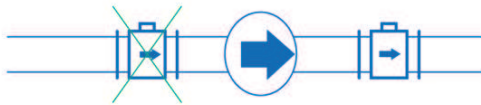

For installations with valves, correct location for the valve is downstream of a sensor.

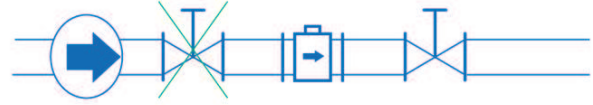

Laminar flow is required to guarantee the accuracy of the readings.

Sensor must be installed in a section of straight pipe with minimum 5 times the pipe diameter upstream and 3 times downstream.

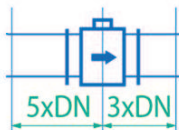

When using pipe reducers, they have to be installed before and after the straight pipe section. The angle of the slope of the reducer should not exceed 8°.

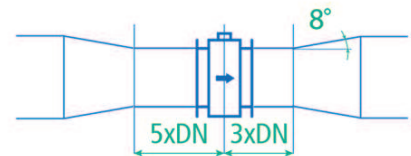

3 GROUNDING

a) PLASTIC PIPE (Grounding with earthing rings)

Ensure continuity of earth between sensor, ring, pipe and liquid

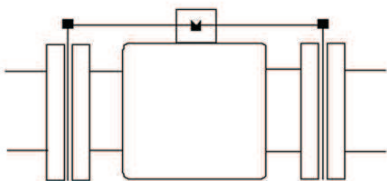

Washers must be used for earthing ring installations. You must use a conductor with a minimum cross-section of 1,5 mm of Copper wire for all grounding.

Nuts and bolts must be tightened using a spanner. Finger tight has no effect



Earthing rings must be used for plastic pipe installation

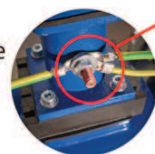

Remember to earth the cable. Grounding of the neck

b) CONDUCTIVE PIPE (Grounding without earthing rings)

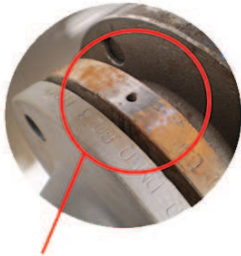
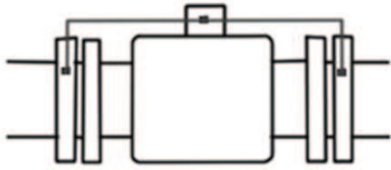

Contact point must be properly cleaned from rust, paint, etc.



See also the installation/operational manual

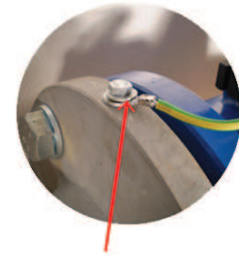

4 CHANGING THE BATTERY

1



1. Connect the new battery pack to the second connector (without losing data)

2



2. Unplug the old battery pack, remove it, reinstall new battery pack

3



3. Activate in USER menu Battery Change (see chapter 9.3)

5 CONNECTION OF THE SENSOR TO THE MOTHERBOARD

Remote and Compact version

Plug the connections into the transmitter

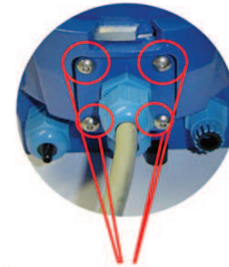

All connections must be properly tightened

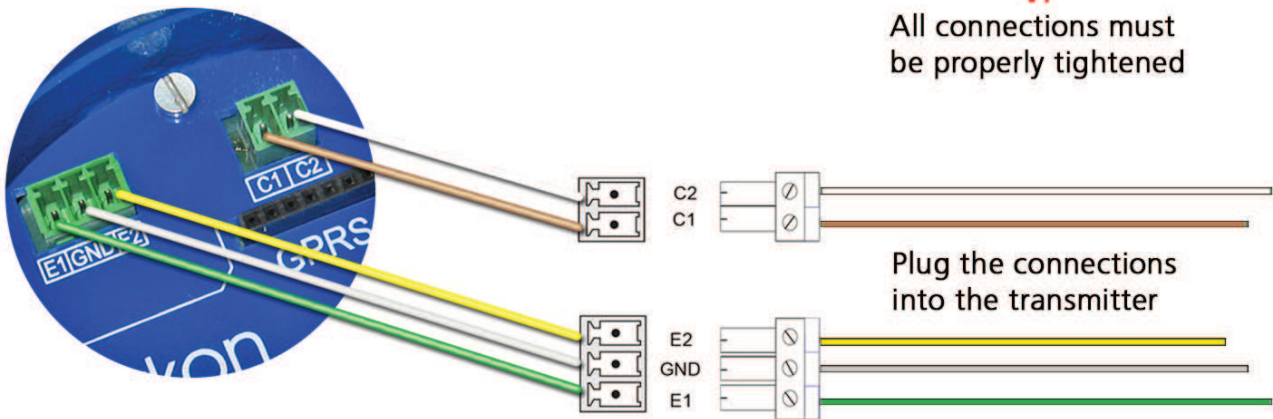

Plug the connections into the transmitter

6 USB CONNECTION

Connection to PC

Unscrew the left blind port



Connect the cable to transmitter

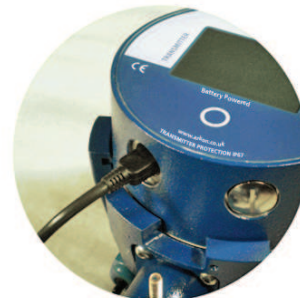

Contact Support

Information required:

Serial number of the flowmeter, FW version, SW version, fault description, photos of installation (if applicable).

Technical support:

support@arkon.co.uk

Windows Live Messenger:

support@arkon.co.uk

Telephone:

+420 543 214 822

