

Instruction Manual

Flow Measurement Transmitter

NivuFlow Mobile 750 / NivuFlow Mobile 750 Ex



Firmware Revision: 3.00

Revised manual

Document revision: 03 / 27.05.2020

Original Manual: German / rev. 03 as of 25.05.2020

NIVUS AG, Switzerland

Burgstrasse 28
8750 Glarus, Switzerland
Phone +41 (0)55 6452066
Fax +41 (0)55 6452014
swiss@nivus.com
www.nivus.de

NIVUS Austria

Muehlbergstrasse 33B
3382 Loosdorf, Austria
Phone +43 (2754) 567 63 21
Fax +43 (2754) 567 63 20
austria@nivus.com
www.nivus.de

NIVUS Sp. z o.o., Poland

ul. Hutnicza 3 / B-18
81-212 Gdynia, Poland
Phone +48 (0) 58 7602015
Fax +48 (0) 58 7602014
biuro@nivus.pl
www.nivus.pl

NIVUS France

67870 Bischoffsheim, France
Phone +33 (0)3 88 9992 84
info@nivus.fr
www.nivus.fr

NIVUS Ltd., United Kingdom

Wedgewood Rugby Road
Weston under Wetherley
Royal Leamington Spa
CV33 9BW, Warwickshire
Phone +44 (0)8445 3328 83
nivusUK@nivus.com
www.nivus.com

NIVUS Middle East (FZE)

Building Q 1-1 ap. 055
P.O. Box: 9217
Sharjah Airport International
Free Zone
Phone +971 6 55 78 224
Fax +971 6 55 78 225
middle-east@nivus.com
www.nivus.com

NIVUS Korea Co. Ltd.

#2502, M Dong, Technopark IT Center,
32 Song-do-gwa-hak-ro, Yeon-su-gu,
INCHEON, Korea 406-840
Phone +82 32 209 8588
Fax +82 32 209 8590
korea@nivus.com
www.nivus.com

NIVUS Vietnam

21 Pho Duc Chinh, Ba Dinh,
Hanoi, Vietnam
Phone +84 12 0446 7724
vietnam@nivus.com
www.nivus.com

Copyrights and property rights

This document and its contents are proprietary to NIVUS GmbH and are not to be reproduced or copied without the express written permission of NIVUS GmbH.

Violations oblige to compensation.



Important Note

This instruction manual may exclusively - even in parts - be copied or translated in any other way with the express written consent of NIVUS GmbH.

Translation

If the device is sold to a country in the European Economic Area (EEA) this instruction manual must be translated into the language of the country in which the device is to be used.

Should the translated text be unclear, the original instruction manual (German) must be consulted or the NIVUS GmbH contacted for clarification.

Copyright

No part of this publication may be reproduced, transmitted, sold or disclosed without prior permission. Damages will be claimed for violations. All rights reserved.

Names

The use of general descriptive names, trade names, trade-marks and the like in this manual does not entitle the reader to assume they may be used freely by everyone. They are often protected registered trademarks even if not marked as such.

Document modifications

Rev.	Modifications	Editor in charge	Date
03	Chap. "5 Warranty" added; chap. "19 Configuration/Device Types" updated; chap. "23.1 Rechargeable Battery Pack", "27 Connecting the Connector Box for Inputs/Outputs" and "36.4.4 Digital Outputs" modified; chap. "52.2 Power Adapter / Battery Charger" added; chap. "53 Dismantling/Disposal": Note to EC WEEE-Directive updated; chap. "Approvals and Certificates" updated; minor text and layout changes	MoG	27.05.2020
02	NIVUS France address modified; chap. "1.3.1 Colour code for wires and single conductors", "5 Liability disclaimer", "22.1.3 Operation/Charging via an Alternative Power Supply", "24.2 Sensor Connection" modified; chap. "24.3 Overvoltage Protection Measures" added; chap. "26 Connecting the Connector Box for Inputs/Outputs": Fig. 26 2 modified; chap. "29 Indication System of Status LED on NivuFlow Mobile"; chap. "30 Setting Up Connection": "Session Timeout" removed; chap. "31.3 Menus": "Alert" added; chap. "35.4.1 Analog Inputs", "37.2.3 Units", "37.2.4 Units Memory" and "38 Parameter Menu Communication" modified; chap. "42 Parameter Menu Alert" added	MoG	17.04.2019
01	First version based on the German document	MoG	25.10.2018
00	---	---	---

Table of contents

<u>Copyrights and property rights</u>	3
<u>Document modifications</u>	4
<u>Table of contents</u>	5
<u>General</u>	10
1 About this manual.....	10
1.1 Applicable documentation	10
1.2 Signs and definitions used	10
1.3 Abbreviations used.....	11
1.3.1 Colour code for wires and single conductors	11
2 Connections and Operating Elements	11
2.1 Power Supply	11
2.1.1 Transmitter.....	11
2.1.2 Rechargeable Batteries	12
2.2 NivuFlow Mobile Operating Elements.....	12
2.3 Interfaces	13
<u>Safety Instructions</u>	14
3 Used symbols and signal words.....	14
3.1 Valuation of the accident level	14
3.2 Warning notices on the product (option)	15
4 Safeguards and Precautions.....	15
5 Warranty.....	16
6 Liability disclaimer	17
7 Use in accordance with the requirements	17
8 Ex Protection	18
9 User's Responsibilities	19
10 Personnel requirements	19
<u>Delivery, Storage and Transport</u>	20
11 Delivery	20
12 Reception inspection	20
13 Storage.....	21
14 Transport.....	21
15 Return.....	21
<u>Product Specification</u>	22
16 Product Construction and Overview.....	22
16.1 Enclosure Dimensions	23
16.2 Connectable Sensors/Devices	23
17 Device identification	24
18 Specifications	25
19 Configuration/Device Types	26

Functional description	27
20 Operating Ranges	27
21 Functional Principles	27
21.1 Flow velocity measurement	27
21.1.1 Cross correlation	27
21.2 Level measurement.....	29
21.2.1 2-wire level sensor.....	29
21.2.2 Water ultrasound	30
21.2.3 Air-ultrasound	30
21.2.4 Pressure	31
Installation and Connection	32
22 General Information on Installation	32
22.1 Installation place	32
22.2 Before Installation	32
22.2.1 PU stickers on enclosure frame	32
22.2.2 Gaskets.....	32
22.2.3 Securing the Instrument	33
22.2.4 Connection Sockets.....	33
23 Electrical Installation/Power Supply	33
23.1 Rechargeable Battery Pack	34
23.1.1 Removing/Inserting the Rechargeable Battery Pack	34
23.1.2 Charging the rechargeable battery pack	35
23.1.3 Operation/Charging via an Alternative Power Supply	37
23.1.4 Operation/Charging with direct connection to mains power.....	38
24 Sensor Installation in General	38
24.1 Sensor Installation Basics	38
25 Installation of Sensors	39
25.1 Cable for Sensor Connection	39
25.2 Sensor Connection.....	39
25.2.1 Connecting Sensors directly to NivuFlow Mobile	39
25.2.2 Connection of Flow Velocity Sensors using the Adapter Box	40
25.3 Overvoltage Protection Measures.....	40
26 Single external Connection for Inputs/Outputs	41
27 Connecting the Connector Box for Inputs/Outputs	41
28 (T-Shape) Antenna for GPRS Data Remote Transmission	43
Putting into Operation	44
29 Notes to Users.....	44
30 Indication System of Status LED on NivuFlow Mobile	44
31 Setting Up Connection	45
31.1 General.....	45
31.2 Android Operating System	45
31.3 iOS Operating System	48
31.4 Windows Operating System.....	51
32 Menu Operation/Overview	54
32.1 Display Overview	54
32.2 Saving Parameters.....	55
32.3 Menus.....	56

Parameter Setting	57
33 General Programming	57
33.1 Save Parameters	57
33.2 Change WLAN Password	57
33.3 Change Instrument SSID	58
33.4 Lost Password	58
33.5 Automatic Data Transmission to USB Stick	59
34 Parameter Setting using Quick Start	59
35 Parameter Functions	62
35.1 Main Menu	62
35.2 Functions of the first Menu Level	63
35.2.1 Menu - Application	63
35.2.2 Menu - Data	64
35.2.3 Menu - System	64
35.2.4 Menu - Communication	65
35.2.5 Menu - Display	65
35.2.6 Menu - Battery (12V)	66
35.2.7 Menu – Quick Start	67
35.2.8 Menu – Alert	68
36 Application Parameters Menu	69
36.1 Menu Measure Place	69
36.1.1 Name of Measurement Place	69
36.1.2 Channel Profiles	69
36.1.3 Sludge Level	75
36.1.4 3D-View	75
36.1.5 Low-Flow Suppression	75
36.1.6 Damping	76
36.1.7 Stability	77
36.2 Setting Parameters in Menu h-Sensors	77
36.2.1 h-Sensor types	77
36.2.2 Define Measuring Ranges	79
36.3 Setting Parameters in Menu v-Sensors	81
36.3.1 Number of Flow velocity sensors	81
36.3.2 Selecting the Sensor Types	82
36.3.3 Sensor mounting position	82
36.3.4 Weighting	86
36.3.5 v-Determination low levels	87
36.3.6 Limitation of velocity evaluation	89
36.4 Menu Inputs/Outputs (analog and digital)	89
36.4.1 Analog Inputs	90
36.4.2 Analog Outputs	91
36.4.3 Digital Inputs	92
36.4.4 Digital Outputs	93
36.5 Diagnostics Menu	95
37 Parameter Menu Data	95
37.1 Trend	96
37.2 Day Totals	98
37.3 Data Memory	99

38	System Parameter Menu	102
38.1	Information	102
38.2	Region Settings.....	102
38.2.1	(Operation) Language	103
38.2.2	Date Format.....	103
38.2.3	Units.....	103
38.2.4	Units Memory	104
38.3	Time/Date.....	105
38.4	Error Messages.....	106
38.5	Service	106
38.5.1	Service Level	107
38.5.2	Restart	107
38.5.3	Powerdown.....	107
38.5.4	Parameter Reset	107
38.5.5	Update NivuFlow	107
38.5.6	Update Bootloader.....	107
38.6	Storage Mode.....	107
39	Parameter Menu Communication	109
40	Parameter Menu Display.....	114
41	Parameter Menu Battery (12V)	115
42	Parameter Menu Quick Start.....	116
42.1	Menu >Quick Start< / >Region Settings<	116
42.2	Menu >Quick Start< / >Measure Place<.....	117
42.3	Menu >Quick Start< / >h-Sensors<	117
42.4	Menu >Quick Start< / >v-Sensor 1<	118
43	Parameter Menu Alert	118
43.1	Menu >Alert< / >Flow<.....	119
43.2	Menu >Alert< / >Level<.....	120
43.1	Menu >Alert< / >Velocity<.....	120
43.1	Menu >Alert< / >Water temperature<	121
43.1	Menu >Alert< / >Battery (12V)<	122
43.1	Menu >Alert< / >Analog Input 1<	123
43.1	Menu >Alert< / >Analog Input 2<	123
43.1	Menu >Alert< / >Analog Input 3<	124
43.1	Menu >Alert< / >Digital Input<	125
Diagnosics		126
44	Diagnosics Menu Principles	126
45	Diagnosics Menu h-Sensors	127
46	Diagnosics Menu v-Sensors	128
47	Diagnosics Menu Inputs and Outputs	129
47.1	Important Information on the Simulation	129
48	Diagnosics Menu Flow profile	130
49	Diagnosics Menu Signal Analysis	131
50	Simulation.....	133

<u>Maintenance and Cleaning</u>	134
51 Maintenance	134
51.1 Maintenance Interval	134
51.2 Customer Service Information	135
52 Cleaning	135
52.1 Transmitter	135
52.2 Power Adapter / Battery Charger	135
52.3 Sensors	135
53 Dismantling/Disposal	136
54 Installation of spare parts and parts subject to wear and tear	136
55 Accessories	136
<u>Index</u>	138
<u>Credits and Licenses</u>	140
56 List of references of the licenses and codes used	140
<u>Approvals and Certificates</u>	141

General

1 About this manual



Important note

READ CAREFULLY BEFORE USE.

KEEP IN A SAFE PLACE FOR LATER REFERENCE.

This instruction manual is for the intended use of the flow measurement transmitter NivuFlow Mobile 750. This manual is oriented exclusively to qualified expert personnel.

Read this instruction manual carefully and completely prior to installation and connection since it contains relevant information on this product. Observe the notes and particularly follow the warning notes and safety instructions.

If you should have problems to understand information contained within this instruction manual either contact the NIVUS GmbH or one of the distributors for further support. The legally associated companies and subsidiaries of NIVUS group cannot be held responsible for damage to persons or material due to incorrectly understood information in this instruction.

1.1 Applicable documentation

For the installation and operation of the complete system extra instruction manuals or technical descriptions may be required apart from this manual.

- Technical Instruction for Correlation Sensors and external Electronic Box
- Installation Instruction for Correlation and Doppler Sensors

These manuals are provided with the auxiliary units or sensors and/or are available as download on the NIVUS homepage.

1.2 Signs and definitions used



Image	Meaning	Remark
	(Action) Step	Action to be performed by you. Note the numbering of action steps. Observe the order of the working steps.
	Cross-reference	Refers to further or detailed information.
>Text<	Parameter or Menu	Indicates a parameter or a menu that is selected or described.
	Reference to document	Refers to an accompanying documentation.

Table 1 Structural elements within the manual

1.3 Abbreviations used

1.3.1 Colour code for wires and single conductors

The abbreviations of colours, wire and components follow the international colour code according IEC 60757.

BK	black	BN	brown	RD	red
OG	orange	YE	yellow	GN	green
BU	blue	VT	violet	GY	grey
WH	white	PK	pink	TQ	turquoise
GNYE	green/yellow	GD	gold	SR	silver

2 Connections and Operating Elements

2.1 Power Supply

2.1.1 Transmitter

The NivuFlow Mobile (Fig. 2-1 no. 1) is supplied by rechargeable battery packs. Once plugged in the batteries are connected to the transmitter via the charging pins (Fig. 2-1 no. 4) supplying the required operating voltage.

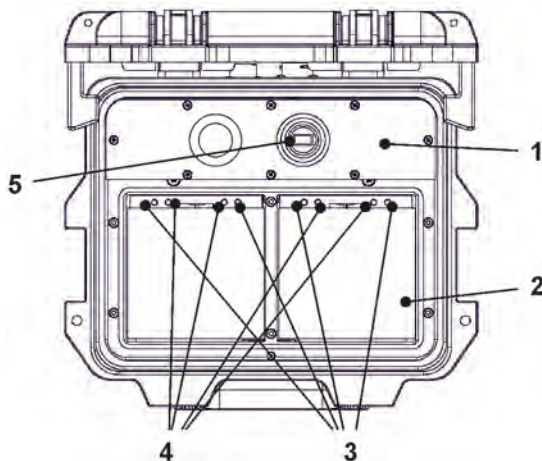

- 1 Transmitter
- 2 Battery compartment (two battery packs; illustration without batteries)
- 3 Guide pins for battery packs
- 4 Charging pins for AC power supply of transmitter
- 5 USB-A interface

Fig. 2-1 Power supply by battery packs (top view)

2.1.2 Rechargeable Batteries

The rechargeable batteries can be charged either in installed condition or while removed by using a battery charger (optional accessory).

WARNING



Risk of explosion when charging battery packs in Ex areas

*Charge rechargeable battery packs outside of Ex areas only.
Do not charge within Ex areas.*

There are two different options to charge the batteries while being installed:

- Power adapter 110...230 V AC using the multifunction socket (Fig. 2-2 no. 1) on the reverse side of the enclosure
- External power source 12...14 V DC (e.g. battery, solar module, fuel cell etc.) using cable via multifunction socket

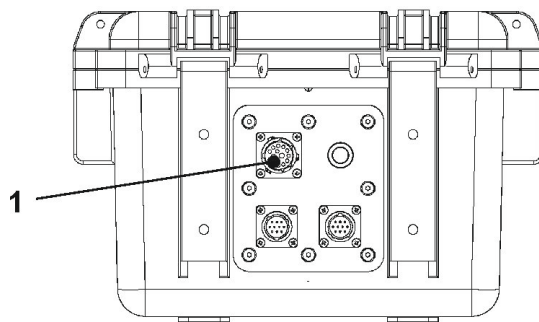

1 Multifunction socket

Fig. 2-2 Charging batteries via multifunction socket



Sensor wiring diagrams can be found in chapter "25 Installation of Sensors".

2.2 NivuFlow Mobile Operating Elements

NivuFlow Mobile itself has no direct operating elements. Instrument operation and the setting of parameters are carried out completely by using smartphone, tablet, notebook and PC.

Use here the PC mouse or the touchscreen.



Also refer to the instruction manuals of your preferred smartphone, tablet, notebook or PC.

2.3 Interfaces

The transmitter is equipped with various interfaces which can be found on the reverse side or on the top of the instrument.

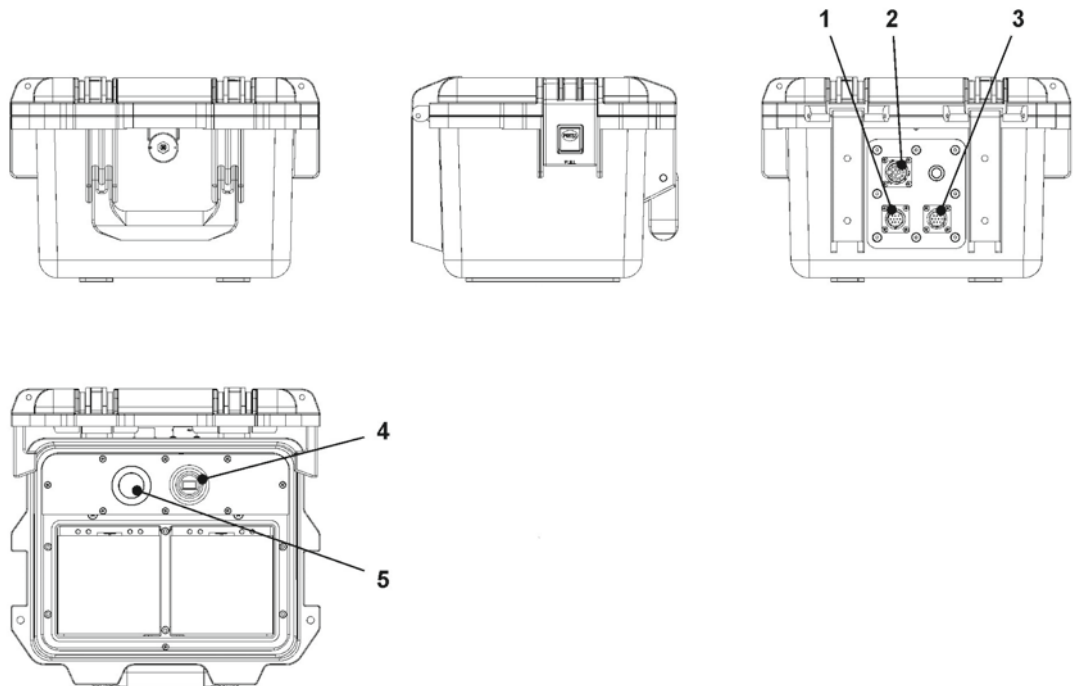

- 1 Sensor socket v2/h
- 2 Multifunction socket I/O
- 3 Sensor socket v1
- 4 USB-A interface (accessible with open cover)
- 5 GPRS SIM card slot (in connection with GPRS antenna)

Fig. 2-3 Available interfaces

Safety Instructions

3 Used symbols and signal words

3.1 Valuation of the accident level



The general warning symbol indicates the risk of personal injuries or death. In the text section the general warning symbol is used in conjunction with the signal words described below.

DANGER

Warnings in high degree of risk



Indicates a high-risk, **imminently** hazardous situation which will result in death or serious injury if not avoided.

WARNING

Warnings in medium degree of risk



Indicates a **possible** danger with medium risk which may result in a life-threatening situation or (severe) bodily injury if it is not avoided.

CAUTION

Warnings in low-risk or property damages



Indicates a possible danger with moderate risk which may result in minor or moderate personal injury or material damage if not avoided.

WARNING

Danger by electric voltage



Indicates a hazard with a high risk of electric shock which may result in a life-threatening situation or (severe) bodily injury if it is not avoided.



Important Note

Contains information that should be highlighted.
Indicates a potentially damaging situation which can result in a damage of the product or an object in its environment.



Note

Contains information and facts.

3.2 Warning notices on the product (option)



General warning label

This symbol is for operators to refer to this instruction manual. Observing the information contained therein is required in order to maintain protection measures provided by the instrument during installation procedures and operation.



Protective conductor

This symbol refers to the protective conductor of the unit. Depending on the mode of installation the instrument shall be operated solely connected to an appropriate protective conductor according to applicable laws and regulations.

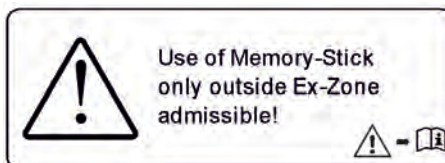
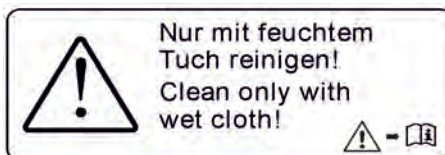
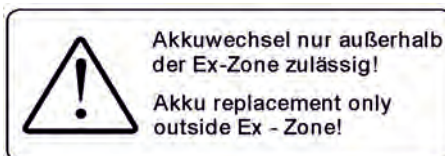

4 Safeguards and Precautions

Working with NIVUS instruments requires to observe and to follow the safety measures and precautions below generally and at any time. These notes and warnings will not be repeated for each description within the document.

WARNING



Check danger through explosive gases

Prior to beginning mounting, installation and maintenance make sure to observe any regulations on safety at work as well as to check the potential risk due to explosive gases. Use a gas warner to check.

When working in the channel system make sure to avoid electrostatic charge:

- Avoid unnecessary movements to minimise the risk of static energy accumulating.
- Discharge any possible static electricity from your body before you begin to install sensors.

Disregarding may lead to personal injury or damage your equipment.

WARNING**Germ contamination**

Please note that due to the operation in the waste water field the measurement system and cables may be loaded with dangerous disease germs. Respective precautionary measures must be taken to avoid damage to one's health.

Wear protective clothing.

WARNING**Observe occupational safety regulations**

Before starting installation work, observing the work safety regulations need to be checked.

Disregarding may lead in personal injury.

WARNING**Do not disable safety devices**

It is strictly prohibited to disable the safety devices or to change the way they work.

Disregarding may lead in personal injury.

WARNING**Disconnect the systems from mains**

Maintenance, cleaning and/or repairs (by qualified personnel only) may only be performed when de-energised.

Disregarding may lead to electric shocks.

**Putting into operation by trained experts only**

The entire measurement system shall be installed and put into operation by trained expert personnel only.

Integrated buffer battery

The exchange of the integrated buffer battery shall be carried out by NIVUS staff or personnel authorised by NIVUS only. Otherwise the guarantee expires.

5 Warranty

The device has been functionally tested before delivery. If it is used as intended (see chapter "7 Use in accordance with the requirements") and the operating instructions, the applicable documents (see chapter "1.1 Applicable documentation") and the safety notes and instructions contained therein, are observed, no functional restrictions are to be expected and perfect operation should be possible.



Please also note in this regard the next chapter "6 Liability disclaimer".

**Limitation of warranty**

In the event of non-compliance with the safety instructions and instructions in this document, the companies of the NIVUS group of companies reserve the right to limit the warranty.

6 Liability disclaimer

The legally associated companies and subsidiaries of NIVUS group assume no liability

- for damages owing to a **change** of this document. The legally associated companies and subsidiaries of the NIVUS group reserve the right to change the contents of this document and this disclaimer at any time and without any notice.
- for damages to persons or objects resulting from **failure to comply** with applicable **regulations**. For connection, commissioning and operation of the sensors all available information and higher local legal regulations (in Germany e.g. VDE regulations) such as applicable Ex regulations as well as safety requirements and regulations in order to avoid accidents shall be adhered to.
- for damages to persons or objects resulting from **improper use**. For safety and warranty reasons, all internal work on the instruments beyond from that involved in normal installation and connection, must be carried out only by qualified NIVUS personnel or persons or companies authorised by NIVUS.
- for damages to persons or objects resulting from the use of instruments in technically **imperfect** condition.
- for damages to persons or objects resulting from the use of instruments **not in accordance with the requirements**.
- for damages to persons or objects resulting from failure to comply with **safety information** contained within this instruction manual.
- for missing or incorrect measurement values or resulting consequential damages due to **improper installation**.

7 Use in accordance with the requirements



Note

The instrument is intended solely for the purpose described below. Modifying or using the instruments for any other purposes without the written consent of the legally associated companies and/or subsidiaries of NIVUS group will not be considered as use in accordance with the requirements.

The legally associated companies and subsidiaries of NIVUS group cannot be held responsible for any damage resulting from improper use.

The user alone bears any risk.

The NivuFlow Mobile 750 transmitter incl. the accompanying sensors is designed for temporary flow measurement of slight to heavily polluted aqueous liquids for open channels and part filled and full pipes.

NivuFlow Mobile 750 is designed and manufactured in accordance with the current state of the art and with the recognised safety rules and regulations applicable at the time this document is issued. Danger to persons or material damage cannot be completely ruled out, however.

The maximum permissible limit values as specified in chapter "18 Specifications" shall be necessarily observed. Any case varying from these conditions which is not approved by NIVUS GmbH in written form is left at the owner's risk.



8 Ex Protection

The portable transmitter NivuFlow Mobile 750 and the accompanying sensors are designed to be used in areas with explosive atmospheres (zone 1).

The following conditions must be observed:

- Programming the unit under Ex conditions is permissible:
 - with the programming person **within** the Ex area as soon as the indicator and operating unit used has an Ex approval
 - with the programming person **outside** of the Ex area as soon as the indicator and operating unit used has no Ex approval
- Maintenance and repairs shall be executed only **outside** of Ex area
- Rechargeable batteries shall be removed/inserted and charged only **outside** of Ex areas
- In general, only rechargeable batteries approved by NIVUS shall be used **within** Ex areas
- Use the USB interface only **outside** of Ex areas
- Replace the SIM card only **outside** of Ex areas
- The instrument shall be (after successful installation at the measurement place) secured against unauthorised opening by using a padlock (holes on the side of the enclosure)

Approval

Transmitter		II 2G Ex eb ib [ib] mb IIB T4 Gb (TÜV 17 ATEX 196722 X)
Sensors		II 2G Ex ib IIB T4 Gb (TÜV 12 ATEX 087812)



Validity of Ex Approval

The Ex approval is only valid in connection with the respective indication on the transmitter or the sensor nameplate.



Declarations of Conformity and Test Reports

For installation and commissioning the EC Declarations of Conformity and Test Reports of the respective authorities shall be strictly followed.



Ex Approval for Sensors

The Ex approval for the sensors is part of the Technical Description for Cross Correlation and Doppler Sensors.

9 User's Responsibilities



Important Note

*In the EEA (European Economic Area) national implementation of the framework directive 89/391/EEC and corresponding individual directives, in particular the directive 2009/104/EC concerning the minimum safety and health requirements for the use of work equipment by workers at work, as amended, are to be observed and adhered to.
In Germany e.g. the Industrial Safety Ordinance must be observed.*

Make sure to have a local operating permit available and observe the associated conditions. In addition to this you must observe environmental requirements and local laws on the following points:

- Personnel safety (accident prevention regulations)
- Safety of work materials and tools (safety equipment and maintenance)
- Disposal of products (laws on wastes)
- Disposal of materials (laws on wastes)
- Cleaning (cleansing agents and disposal)

Connections

Operators shall make sure prior to operating the instrument that during installation and initial start-up the local regulations (such as regulations for electrical connection) are observed.

Keep the manual

Keep this manual in a safe place and make sure it is available for the users of this product at any time.

Provide the manual

In case of selling the instrument this instruction manual shall be provided to the purchaser since it is a part of the standard delivery.

10 Personnel requirements

Installation, commissioning and maintenance shall be executed only by personnel meeting the demands as follows:

- Expert personnel with relevant training and appropriate qualification
- Personnel authorised by the plant operator



Qualified personnel

within the context of this documentation or the safety notes on the product itself are persons who are sufficiently familiar with installation, mounting, starting up and operation of the product and who have the relevant qualifications for their work; for example:

- I. *Training, instruction or authorisation to activate/deactivate, isolate, ground, and mark electric circuits and devices/systems according to the safety engineering standards.*
- II. *Education and instruction according to the standards of safety engineering regarding the maintenance and use of adequate safety equipment.*
- III. *First aid training*

Delivery, Storage and Transport

11 Delivery

The standard delivery of the NivuFlow Mobile 750 basically contains:

- Transmitter type NivuFlow Mobile 750 (according to shipping documents)
- Ring magnet (solenoid)
- USB stick
- Screw driver for hexagon socket screws
- PU stickers (two pieces: 31x17x3.5 mm) to avoid vacuum in the enclosure in case of being returned (via airfreight) to NIVUS (e.g. for maintenance)
- T-shape antenna (only for versions with internal GPRS / UMTS / LTE modem)
- Padlock (only for Ex versions)
- Instruction manual (incl. certificate(s) of conformity) containing any relevant information on how to operate the NivuFlow

Check extra accessories depending on your order and by using the delivery note.

12 Reception inspection

Check the packaging for visible damage immediately after receipt. Any possible damage in transit shall be instantly reported to the carrier. Furthermore a written report shall be sent to NIVUS GmbH in Eppingen.

Incomplete deliveries shall be reported in writing either to your local representative or directly to the NIVUS head office in Eppingen within two weeks.



Important note

Mistakes cannot be rectified later!

🔄 Prior to the first use:

1. Open enclosure cover.
2. Remove both PU stickers (two pieces; 31x17x3.5 mm), if available, from the left and right enclosure frame (Fig. 15-1 no. 1). The stickers have been attached prior to shipping (via airfreight) to prevent the enclosure from getting closed and to avoid vacuum formation due to extreme temperature changes during shipping.

13 Storage

The permissible maximum values regarding ambient conditions such as temperature and humidity according to chapter "18 Specifications" shall be necessarily observed.

Protect the NivuFlow Mobile from corrosive or organic solvent vapours, radioactive radiation as well as strong electromagnetic radiation.

➡ To store the instrument:

1. Remove the batteries.
2. If the hoop guards should be mounted to attach the Connector Box remove the guards (lack of space) and attach the rubber buffers instead.



Rubber buffers

Necessarily attach the rubber buffers

- *to prevent the hidden fastening plates on the reverse side of the NFM in the screw channel from getting lost. The fastening plates are essential since they provide the threads to fasten the hoop guards and additionally stabilise the guards on the NFM.*
- *because the buffers are designed as impact protection for NFM connections and protect the sockets etc. from being damaged.*

14 Transport

Take precautionary measures and use lashing straps or similar to protect the NivuFlow from heavy shocks or vibrations.

15 Return

In case of a required reshipment return the unit at customer cost to NIVUS GmbH in Eppingen using the original packaging.

Insufficiently franked shipments will not be accepted!

➡ Prior to shipping (via airfreight):

1. Attach PU stickers (two pieces; 31x17x3.5 mm) right and left on the enclosure frame (Fig. 15-1 no. 1). This prevents the enclosure from getting closed and eliminates vacuum formation due to extreme temperature changes.
2. Place the NivuFlow Mobile safely in the original packaging for transport.

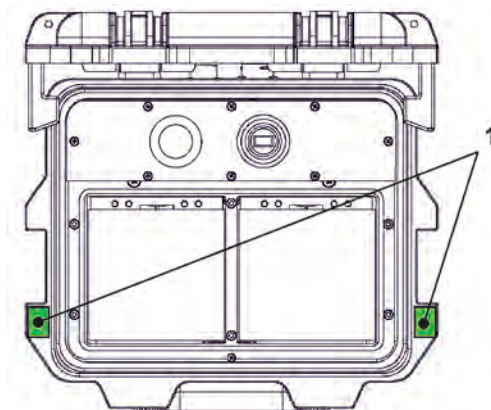
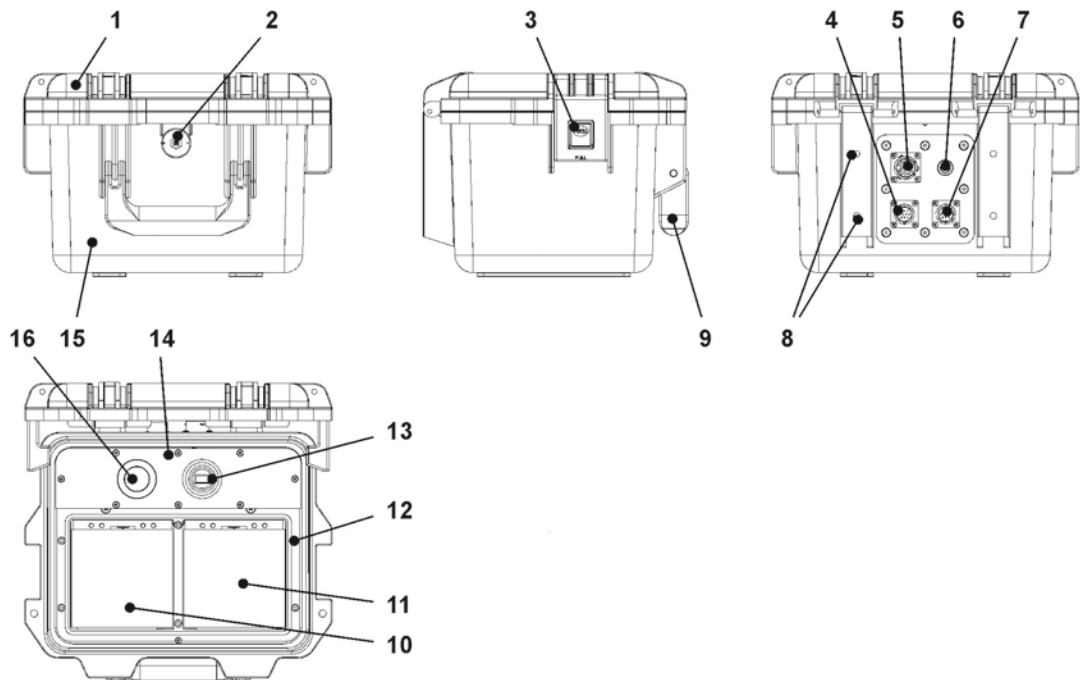

Fig. 15-1 Attachment position for PU stickers

Product Specification

16 Product Construction and Overview



- 1 Enclosure cover
- 2 LED (status indication) and reed contact (wake-up using solenoid)
- 3 Lock (both sides)
- 4 Sensor socket v2/h
- 5 Multifunction socket I/O
- 6 GPRS antenna socket
- 7 Sensor socket v1
- 8 Fastening holes for rubber buffers or hoop guards
- 9 Handle
- 10 Left battery pack receptacle
- 11 Right battery pack receptacle (position to charge the battery)
- 12 Cover (not shown) above batteries with six non-detachable hexagon socket screws
- 13 USB-A interface
- 14 NivuFlow Mobile 750 transmitter (IP67)
- 15 Enclosure (IP68 with cover closed)
- 16 GPRS SIM card slot (in connection with GPRS antenna)

Fig. 16-1 Device construction NivuFlow Mobile 750 with enclosure

16.1 Enclosure Dimensions

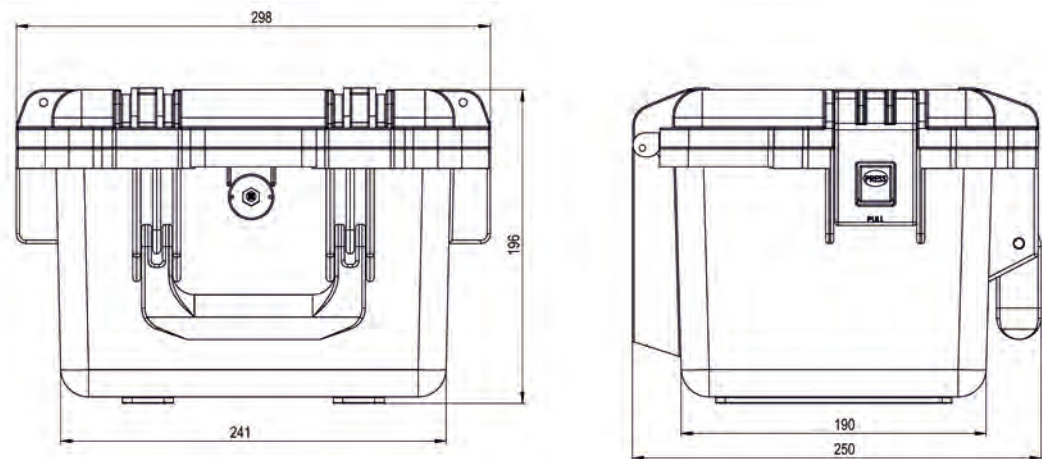
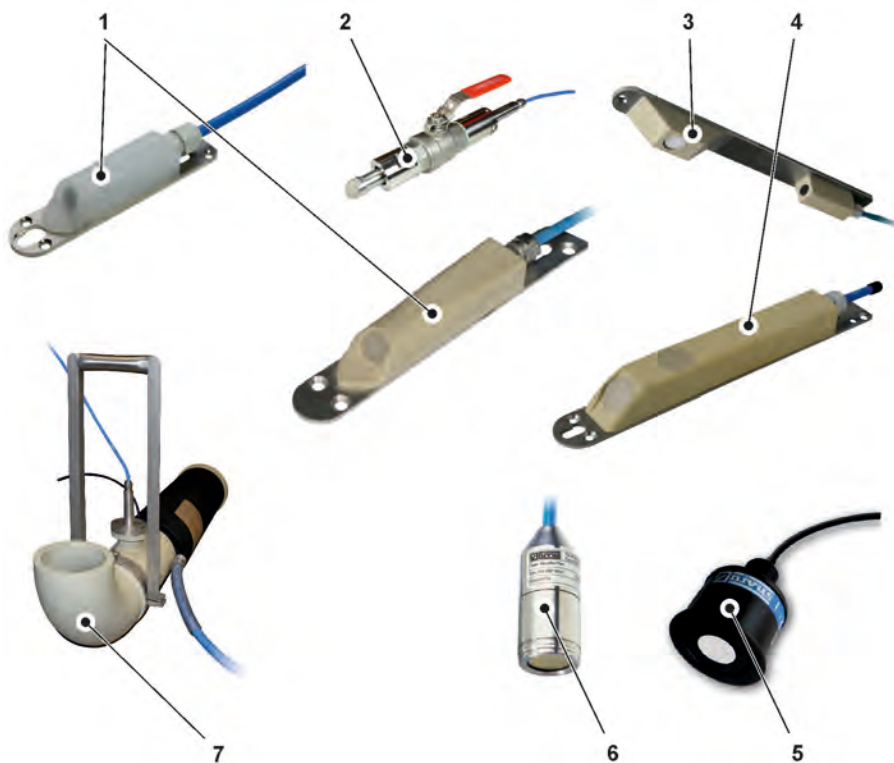

Fig. 16-2 Enclosure

16.2 Connectable Sensors/Devices

The photo below provides an overview on the connectable sensors.



- 1 CSM Flow velocity measurement wedge sensor
- 2 CSM Flow velocity measurement pipe sensor
- 3 DSM-L0 Level measurement wedge sensor
- 4 CSP flow velocity / level measurement combi wedge sensor
- 5 i-Series level sensor
- 6 HSB0 NBP Submersible sensor for level measurement
- 7 NPP Pipe measuring section

Fig. 16-3 Connectable sensors/devices overview

17 Device identification

The instructions contained within this manual are valid only for the type of device specified on the title page. The name plates are fixed on the side of the enclosure and contain the following:

- Name and address of NIVUS GmbH
- CE label
- Information on type and series incl. article and series number
- Year of manufacture: the first four digits of the serial number represent the year and the week number of manufacture (1911.....)
- Ex protection label
- Environmental conditions in operation

In case of enquiries and ordering replacement parts it is important to specify article number as well as the serial number of the respective transmitter or sensor. This ensures correct and quick processing.



Fig. 17-1 Nameplate NivuFlow Mobile 750 (Example Ex-Version)

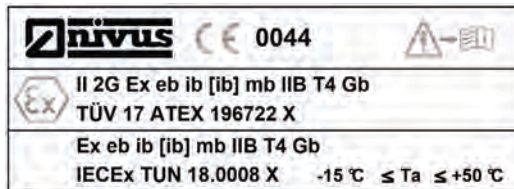

Fig. 17-2 Nameplate NivuFlow Mobile 750 Ex-Version (additionally)



Check nameplates

Check the delivered instrument for accordance with your order by identifying the nameplate.



The declaration(s) of conformity and the EU-Type Examination Certificate(s) are located at the end of the manual.

18 Specifications

Measurement principle	<ul style="list-style-type: none"> - Flow velocity measurement using high accurate, spatially allocated ultrasonic cross correlation - Level measurement depending on sensor type using transit time measurement via air- or water-ultrasound, pressure probe or mA-input for level measurement (2-wire level sensor)
Power supply	<ul style="list-style-type: none"> - 1...2x rechargeable batteries 12 V / 15 Ah, VRLA-AGM - Battery charger 100...240 V AC / 50...60 Hz / 50 VA
Enclosure	<ul style="list-style-type: none"> - Material: HPX high performance synthetic resin - Weight: approx. 4.7 kg (without batteries and hoop guards) - Protection: IP68 closed / IP67 open
Ex approvals/ other approvals	<ul style="list-style-type: none"> - ATEX: TÜV 17 ATEX 196722 X - IECEx: TUN18.0008X
Operating temperature	-15 °C...+50 °C
Storage temperature	-15 °C...+70 °C
Max. humidity	90 %, non-condensing
Display	Status LED (RGB)
Operation	Solenoid switch; via WLAN with display and operating module (smartphone, tablet, notebook etc.)
Inputs	<ul style="list-style-type: none"> - 2x 0/4...20 mA (active/passive) - 1x 0/4...20 mA (passive) - 1x active digital input - 1x socket for power adapter or alternative power supply
Outputs	<ul style="list-style-type: none"> - 1x analog output 0...10 V - 1x potential-free digital output as SPDT / bistable - 1x USB-A for readout of measurement values via USB stick
Storage cycle	5 sec. to 60 min., time-cyclic or event-based
Data memory	Internal; 182,398 measurement cycles
Data transmission/ communication	<ul style="list-style-type: none"> - via plug-in USB stick - via WLAN - option: via GPRS / UMTS / LTE

Table 2 Specifications

Sensors

Construction and description of the according sensors as well as the specifications can be found in the according instruction manuals or technical descriptions.

19 Configuration/Device Types

The portable measurement transmitter is available in different versions as shown in the overview table below.

From the article number the type of device can be specified.

NFM-	Design
	07500 Portable flow measurement transmitter for open channels and part filled and full pipes 000 Standard device E00 With ATEX approval Zone 1
	0750G Portable flow measurement transmitter for open channels and part filled and full pipes with data transmission 0E0 With modem board Europe (EC21-E) ^{*1} 0G0 With modem board Global (EG25-G) ^{*2} 0EG With modem board Europe (EC21-E) ^{*1} With Global-wide SIM card EE0 With ATEX approval Zone 1 With modem board Europe (EC21-E) ^{*1} EG0 With ATEX approval Zone 1 With modem board Global (EG25-G) ^{*2} EEG With ATEX approval Zone 1 With modem board Europe (EC21-E) ^{*1} With Global-wide SIM card
NFM-	

^{*1} Area of operations: Europe, Middle East, Africa, Korea, Thailand, India

^{*2} Area of operations: Global

Table 3 Product structure NFM 750



Accessories see chapter "55 Accessories".

Functional description

20 Operating Ranges

The NivuFlow Mobile 750 is a portable measurement system for flow measurement. The instrument is designed mainly for measurement in slight to heavily polluted aqueous liquids of various compositions.

The system can be used in part filled and full flumes, channels and pipes featuring various shapes and dimensions.

An overview on connectable sensors can be found in chapter “16.2 Connectable Sensors/Devices”.



Note on the ultrasonic reflection principle

The measurement method is based on the ultrasound reflection principle.

Hence, it is indispensable for the system to work that there are particles in the water, which are able to reflect the ultrasonic signal sent by the sensor (dirt particles, gas bubbles or similar).

21 Functional Principles

21.1 Flow velocity measurement

21.1.1 Cross correlation

The piezo crystal has a slope to the flow direction and operates as a flow velocity sensor. Here an ultrasonic burst with a defined angle is sent into the medium. All the particles in the measurement path (air, dirt) reflect a small amount of the ultrasonic signal. The result is a particular signal depending on shape and size of the particles.

Hence, the multitude of the reflected signals results in a reflection pattern (see Fig. 21-1). The piezo crystal receives this pattern again, which then is converted into electric signals and will be saved in a built-in digital signal processor (DSP).

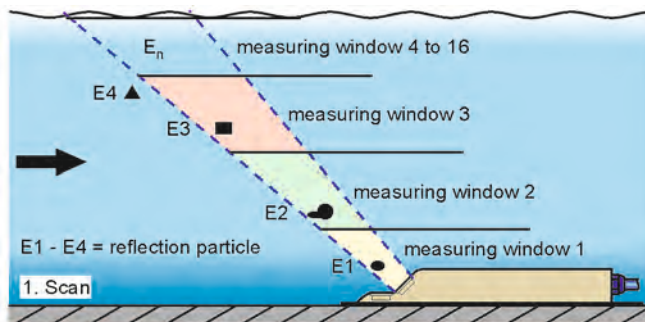

Fig. 21-1 Situation at first signal detection

After a certain period a second ultrasonic burst is sent into the medium. The newly generated reflection signal is saved in the DSP too.

In various flow levels there are different flow velocities (flow velocity profile).

Depending on the level, the reflecting particles' movement away from the first measurement point therefore varies. Hence, a distorted reflection pattern results (see Fig. 21-2).

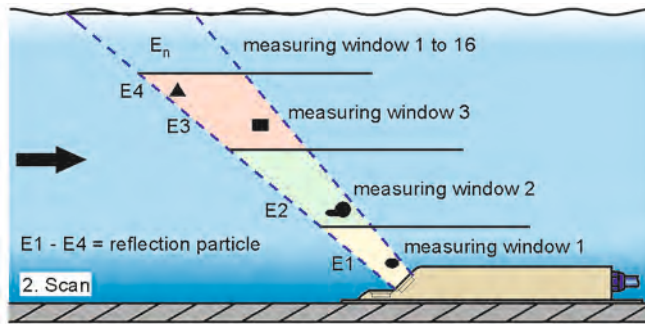

Fig. 21-2 Situation at second signal detection

The DSP checks both received reflection patterns for similarities using the cross correlation method. All existing signal differences (caused by new or rotated particles) are rejected so that two similar but temporarily offset signal patterns are left for velocity evaluation.

Depending on the flow levels both patterns are subdivided into 16 measurement windows.

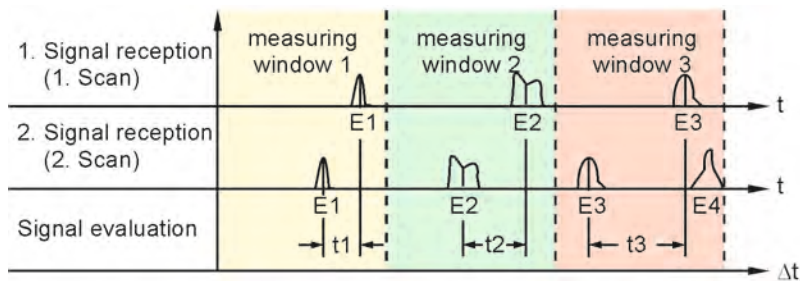

Fig. 21-3 Echo signal images and evaluation

Based on the beam angle, the interval between both transmitted signals and the shift of the signal pattern therefore in each single measurement window the flow velocity can be determined.

It mathematically strings the single flow velocities together which results in the flow profile of the acoustic path.

This velocity profile is indicated directly on the display of the NivuFlow.

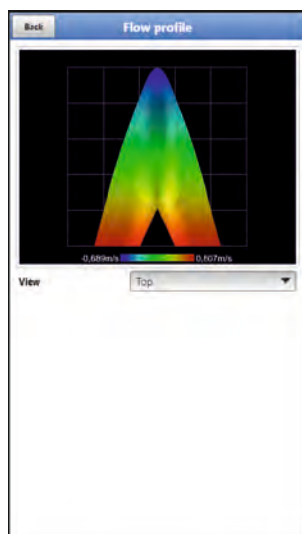

Fig. 21-4 Determined flow profile

If a sufficient calming section is available on the measurement place it is possible to compute a 3-dimensional flow distribution (see Fig. 21-4). The result is based on the geometric data of the flume and the velocity distribution.

In asymmetric flow profiles and heavily structured profiles it is recommended to use more than one flow velocity sensor. The entered sensor positions and the according individual vertical V-profiles are included with the overall 3D-profile and are indicated as well.

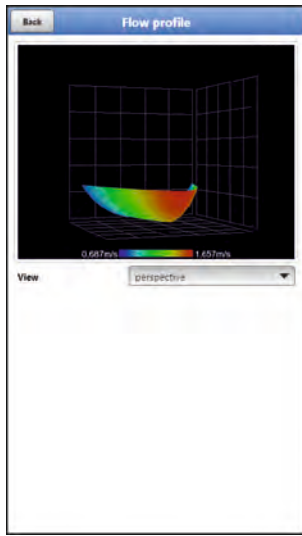

Fig. 21-5 Computed 3-dimensional flow profile

Taking this flow velocity distribution as a basis, the flow rate can be calculated and indicated by considering channel shape, channel dimensions and filling level. This flow rate is available as free programmable analog signal or as impulse signal on the transmitter output.

21.2 Level measurement

21.2.1 2-wire level sensor

It is possible to directly connect 2-wire sensors supplied by the NivuFlow Mobile 750 (e.g. NivuBar Plus or i-Series sensor).



Measurement ranges of the i-Series sensors

i-Series sensors have pre-programmed measurement ranges. For further reference see the i-Series sensors instruction manual.

i-Sensors can be put into operation even without using a HART modem.

To do so enter the sensor's measurement span in the parameter "Value at 20 mA". Depending on the sensor installation height it may be necessary to additionally set a negative offset value.

	i-3	i-6	i-10	i-15
Distance to sensor face in [m] at 4 mA (empty) 0 %	3.0	6.0	10.0	15.0
Distance to sensor face in [m] at 20 mA (full) 100 %	0.125	0.300	0.300	0.500
Max. possible measurement span (value at 20 mA) in [m]	2.875	5.7	9.7	14.5

Table 4 i-Series sensors measurement span

21.2.2 Water ultrasound

The Type CSP-V2H1 and CSP-V2U1 sensors are equipped with a horizontal crystal element used for level measurement based on the transit time method using water-ultrasound.

The measurement uses the time between transmission and reception of an impulse being reflected on the water surface.

$$h_1 = \frac{1}{2} \times (c \times t_1)$$

- with:
 - h = filling level
 - c = sound running time
 - t_1 = time between transmitted and received signal

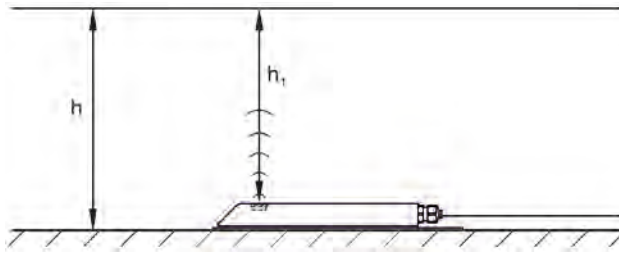

Fig. 21-6 Determined filling level

At a medium temperature of 20 °C the sound running time in water is 1480 m/s.

The temperature-dependent deviation is 0.23 % per Kelvin.

To achieve level measurements with millimetre accuracy, the medium temperature is investigated permanently. The investigated temperature is used to correct the sound running time for calculation purposes.

The fixed level value is added to the determined value h_1 . The result is the total flow level h.

21.2.3 Air-ultrasound

Level is measured via air-ultrasound from top down by using a contactless air-ultrasonic sensor Type DSM-L0. This sensor is used to measure low filling levels. It must be installed exactly in the centre of the channel crown ($\pm 2^\circ$) parallel to the water surface.

Analogous to the transit time method based on water-ultrasound, a signal is transmitted too. In this case, however, the signal is sent through the air towards the water surface from where it is reflected. The measured transit time provides the distance between sensor and water surface and hence the filling level of the medium.

Since the air temperature may lead to deviations in the transit time the temperature is determined and will be considered during internal calculations.

21.2.4 Pressure

The CSM-V1D0 sensor generally operates with a hydrostatic level measurement and the CSP-V2D0/V2U1 sensors can be optionally equipped with an additional hydrostatic level measurement.

The piezoresistive pressure sensor operates based on the relative pressure principle. The pressure of the static water column above the sensor is direct proportional to the filling level. Fluctuations in atmospheric pressure are compensated by a small air tube, which is integrated into the sensor cable. The pressure sensor allows determining flow levels even if the sensor has been installed out of the centre of the channel bottom.

The pressure sensor is adjusted by entering a manually determined reference value at the initial start-up. Additionally, a height caused by the sensor installation is added.

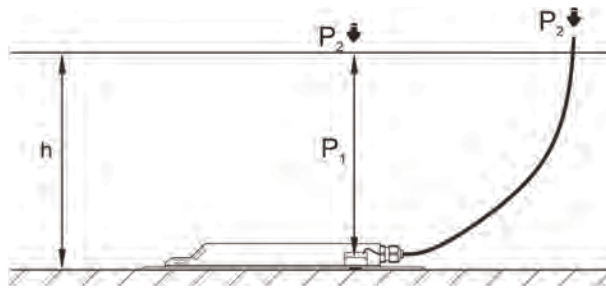

Fig. 21-7 Determined filling level

Installation and Connection

22 General Information on Installation

WARNING**Check danger through explosive gases**

Prior to beginning mounting, installation and maintenance make sure to observe any regulations on safety at work as well as to check the potential risk due to explosive gases. Use a gas warner to check.

When working in the channel system make sure to avoid electrostatic charge:

- *Avoid unnecessary movements to minimise the risk of static energy accumulating.*
- *Discharge any possible static electricity from your body before you begin to install sensors.*

Disregarding may lead to personal injury or damage your equipment.

22.1 Installation place

For safe installation at the chosen place the measures below must be taken:

- ➡ Protect the transmitter from direct sunlight. Install a protective cover if necessary.
- ➡ Observe the permitted ambient temperature.
- ➡ Do not expose the transmitter to heavy vibration or mechanical shocks.

Selecting the installation place strictly avoid:

- Corrosive chemicals or gases
- Radioactive radiation
- Installation close to footpaths or travel ways

22.2 Before Installation

CAUTION**Suspend the instrument only by using appropriate safety belts**

The instrument shall be suspended into shafts or manholes only by using the carrying handle and appropriate belts, ropes or similar.

It is not allowed to suspend the device by the sensor cable since this may lead to cable break, leaky plug connection or the transmitter may be torn off.

22.2.1 PU stickers on enclosure frame

- ➡ Prior to first use of the NivuFlow Mobile 750 make sure that the PU stickers have been removed. If not, remove the stickers and clean the enclosure frame if necessary.
- ➡ See chapter "12 Reception inspection".

22.2.2 Gaskets

- ➡ Check the gaskets on the enclosure cover.
Before closing the cover make sure that the gasket is clean and undamaged, so:
 1. Remove debris and/or dirt.
 2. Replace defective gaskets.
 3. Apply silicone grease if necessary.



Gaskets

The NIVUS GmbH cannot be held responsible for any instrument damage resulting from the use of defective or leaking gaskets.

22.2.3 Securing the Instrument

- Secure the transmitter from being washed away.
When installed in shafts or canals tending to overflow the transmitter shall be secured against being washed away unintentionally (use suspension bracket, plastic/stainless steel rope, chain or similar).

22.2.4 Connection Sockets

- To protect open, unused connection sockets on the reverse side of the instrument from dirt or shocks lock the sockets by using the attached caps prior to installation.

The protection degree of the (closed) instrument is IP68 even with open connection sockets. Damaged or lost caps can be purchased from NIVUS.

23 Electrical Installation/Power Supply

WARNING



Danger due to electric voltage

*Remove the rechargeable batteries from the instrument and if connected to mains power via the multifunction socket disconnect from mains.
Working on the electric connections may induce the risk of electric shocks. Observe electric specifications as specified on the nameplate.
Disregarding may lead to personal injury.*



Note

Observe the local installation directives.

- Make sure to fulfil the requirements mentioned below:
 1. Observe that the installation shall be carried out only by qualified expert personnel.
 2. For electric installation follow the legal requirements of the according country (in Germany e.g. VDE 0100).
 3. Observe further (local) statutory standards, regulations and technical rulings.
 4. Before feeding the rated voltage the installation of transmitter and sensors must be completed. Verify whether the installation is correct.



A description on how to connect the sensors can be found starting page 39.

CAUTION



Do not loosen any screws

Do not loosen any screws on the transmitter except the undetachable hexagon socket screws of the battery compartment cover!

Keep the battery compartment locked during operation.

23.1 Rechargeable Battery Pack

NivuFlow Mobile usually operates with a rechargeable battery pack by default. This ready-to-use battery pack allows for long measuring periods.

➡ Ready-to-use battery packs are obtainable on order at NIVUS (see chap. "55 Accessories").

The battery pack is stored in the according battery compartment. An additional battery pack can be plugged right next to it. Since both sockets are almost equivalent the battery socket can be selected freely if only one battery pack is used.

- While **Charging** only the battery plugged into the right socket is charged however, and the battery will be charged only up to approx. 75 %.
- When **Discharging** the battery with the higher capacity (independent of the socket) is used until the capacity of both batteries has reached the same level. After that both batteries are discharged equally.

Moreover, the battery type used or the number of inserted batteries should be specified in the >Battery (12V)< menu to correctly indicate the remaining battery power in the >System</>Information< menu.

The battery compartment is locked with a cover and six non-detachable hexagon socket screws.



Installation of spare parts/parts subject to wear and tear

The use of spare parts/parts subject to wear and tear (such as rechargeable batteries) not approved by NIVUS will invalidate the guarantee.

23.1.1 Removing/Inserting the Rechargeable Battery Pack

WARNING



Risk of explosion removing/inserting the battery pack in Ex areas

Always remove/insert the rechargeable battery pack outside of Ex areas. Never replace the battery within an Ex area.

With the rechargeable battery pack removed make sure to not short-circuit the poles with external objects. This may generate very high short circuit currents resulting in the development of excessive heat or even fire which might destroy the rechargeable battery pack.

Observe the specifications on the rechargeable battery pack.

The rechargeable battery can be replaced even in damp weather conditions or during rain. The battery compartment is completely separated from the transmitter.

➡ Procedure:

1. Loosen the six non-detachable hexagon socket screws of the cover.
2. Remove the cover.
3. Remove the plugged battery on the grip belt.
4. After reinserting the rechargeable battery refit the cover and tighten the non-detachable hexagon socket screws of the cover finger-tight.

23.1.2 Charging the rechargeable battery pack

The rechargeable battery is normally shipped in discharged condition.

Fully charge the battery **prior to the initial instrument start**.

NIVUS recommend charging the battery outside of the instrument by using the power adapter/battery charger to ensure 100 % of charging capacity. If built in, the battery will be charged only up to approx. 75 %.

WARNING



Risk of explosion removing/inserting and charging the battery pack in Ex areas

The rechargeable battery pack shall be removed/inserted and charged only out of Ex areas. Never do so within Ex areas since otherwise explosion protection cannot be guaranteed.



Power adapter/battery charger

To charge the rechargeable battery pack use the power adapter/battery charger (Fig. 23-1 no. 1; NFM0 ZLAD) (available from NIVUS GmbH at extra costs) only. Observe the specifications attached on the power adapter/battery charger.

Using inappropriate battery chargers may destroy the battery (e.g. due to leaking of battery cells, explosion or similar).



- 1 Power adapter/battery charger with connection cable for the multifunction socket on NFM or the charging tray
- 2 LED indicating the charging status

Fig. 23-1 Power adapter/battery charger

Disconnect the power adapter/battery charger (Fig. 23-1 no. 1) from mains power before you connect/disconnect it to/from a rechargeable battery.

The built-in LED (Fig. 23-1 no. 2) indicates the charging status.

Colour/LED Status	Description
Yellow	Charging process
Green	Trickle charging
LED not lit	Reversed polarity, short circuit or no mains power

Charging the inserted battery pack

See chapter "23.1.4 Operation/Charging with direct connection to mains power".

Charging the removed battery pack

➡ Procedure:

1. Place the charging tray in a safe and dry place on a stable and horizontal surface. Make sure the charging tray itself is dry too.

2. Take suitable measures to ensure that unauthorised persons may not access the devices during the charging process.
3. Plug the battery pack (Fig. 23-2 no. 1) into the charging tray (Fig. 23-2 no. 2) with the upside down.
4. Plug the power adapter/battery charger (with connection cable for multifunction socket) into the charging socket (Fig. 23-2 no. 3) and connect to mains power supply. The batteries are charged via the charging contacts (Fig. 23-2 no. 4). Observe the LED colour/status on the power adapter/battery charger.
5. To avoid short circuits on the charging contacts/poles after the charging process is finished, first disconnect the power adapter/battery charger from mains power and then remove the rechargeable battery pack.

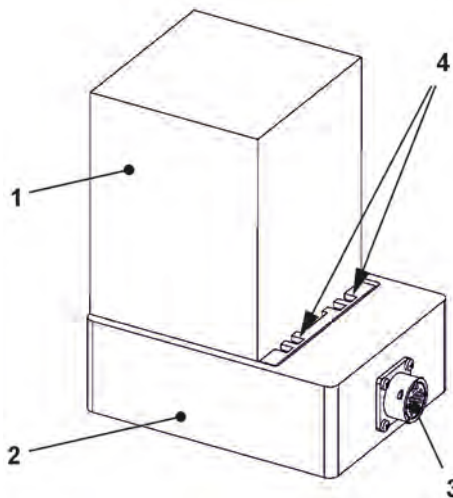

- 1 Rechargeable battery pack (plugged upside down)
- 2 Charging tray
- 3 Charging socket for connection of power adapter/charger
- 4 Charging contacts

Fig. 23-2 Rechargeable battery pack in charging tray

The maximum battery capacity will decrease over time. This impairs the battery life which, however, cannot be considered by the integrated battery life calculation.

If exposed to very low or very high ambient temperatures and long periods of use the capacity of the battery pack will decrease.



Battery life

Rechargeable batteries are wear parts and must be replaced once the charge capacity decreases considerably.

The battery life depends on the frequency of use.

Use for measurements

The battery should be charged every time before the NivuFlow Mobile is used.

Remove unused battery packs from the battery compartment after the last measurement and store them in a dry and frost-free place.



Installation of parts subject to wear and tear

The use of replacement parts/parts subject to wear and tear (e.g. rechargeable batteries) which are not approved by NIVUS invalidates the guarantee.

Battery disposal

Always observe environmentally compatible disposal of rechargeable batteries.

Worn batteries can be either returned to the manufacturer or can be taken to respective collecting points.

23.1.3 Operation/Charging via an Alternative Power Supply

WARNING



Risk of explosion removing/inserting and charging the battery pack in Ex areas

Always remove/insert and charge the rechargeable battery pack outside of Ex areas. Never replace the battery within an Ex area.

By using the multifunction socket the NivuFlow Mobile can be also operated with alternative power sources such as external rechargeable batteries, solar panels or external mains power adapter.

WARNING



Danger of explosion when operated using direct external power supply in Ex area

*Operate the device using direct **external** power supply **out of Ex areas only**. **Never** do so within Ex areas.*

During operation the battery pack is charged in the right-hand slot additionally. NIVUS, however, recommend the use of the battery charger since the battery will be charged to approx. 75 % of the total capacity when inserted (see chapter "23.1.2 Charging the rechargeable battery pack").

NIVUS provides a particular 2-wire connection cable (*NFM0 ZVER PS*) with open cable ends on one side and a plug for the multifunction socket on the other side.

The NivuFlow Mobile power input accepts 12...14.5 V and is protected against short-time overvoltage, overcurrent and reverse polarity.



Charge/Discharge battery sockets

While charging only the battery plugged into the right socket is charged however.

When discharging the battery with the higher capacity (independent of the socket) is used until the capacity of both batteries has reached the same level. After that both batteries are discharged equally.

23.1.4 Operation/Charging with direct connection to mains power

Thanks to the combined power adapter/battery charger (see Fig. 23-1) NivuFlow Mobile can be also operated directly with 100...240 V AC mains power.

WARNING



Danger of explosion during operation with direct mains power connection in Ex area

Do not operate the instrument within Ex areas using direct mains power connection but only out of Ex areas.

During operation the battery pack is charged in the right-hand slot additionally. NIVUS, however, recommend the use of the battery charger since the battery will be charged only to approx. 75 % of the total capacity (see chapter "23.1.2 Charging the rechargeable battery pack").

WARNING



Risk of explosion removing/inserting and charging the battery pack in Ex areas

Always remove/insert and charge the rechargeable battery pack outside of Ex areas. Never replace the battery within an Ex area.

Plug the battery to charge into the right battery socket and connect the power adapter/battery charger (Fig. 23-1) to the multifunction socket of the NivuFlow Mobile. Leave the battery in the instrument to charge it during mains power operation. In case of power failure the battery is used as buffer.



Charge/Discharge battery sockets

While charging only the battery plugged into the right socket is charged however.

When discharging the battery with the higher capacity (independent of the socket) is used until the capacity of both batteries has reached the same level. After that both batteries are discharged equally.

24 Sensor Installation in General

This chapter describes the sensor types and where they are usually installed. You can find detailed installation instructions for the individual sensor types in the respective installation instruction.



Note

Always ensure compliance with the safety regulations during installation works.

24.1 Sensor Installation Basics

The sensor installation at the measurement place extremely depends on the conditions on site. Therefore always make sure that there are proper hydraulic conditions and an appropriate calming section available on site. Sensor type and sensor fastening need to be determined depending on the measurement place.



Detailed information on how to select a calming section and the installation of sensors can be found in the according installation instruction.

The measurement place parameters need to be set prior to installation. Appropriate preparation measures and the measurement place dimensions can be taken from the respective plant documents.

➡ Information on how to set measurement place parameters can be found in chapter “Parameter Setting” starting at page 57.

25 Installation of Sensors

25.1 Cable for Sensor Connection

The sensors are equipped with a permanently attached cable.

25.2 Sensor Connection

A list of connectable flow velocity sensors can be found in chapter “16.2 Connectable Sensors/Devices”.

25.2.1 Connecting Sensors directly to NivuFlow Mobile

The sensors can be connected on the reverse side of the NivuFlow Mobile unit to sockets v1, v2/h or Multi I/O. A maximum of three sensors in total can be connected directly to the NivuFlow Mobile simultaneously with only one connecting option per sensor type. Not more than one CSM/CSP/NPP flow velocity sensor (Fig. 25-1), one DSM-L0 (Fig. 25-2) level sensor and one i-Series/NivuBar Plus (Fig. 25-3) sensor can be connected directly.



Fig. 25-1 Connection of flow velocity sensor CSM, CSP and NPP



Fig. 25-2 Connection of level sensor DSM-L0



Fig. 25-3 Connection of level sensor i-Series and NivuBar Plus

25.2.2 Connection of Flow Velocity Sensors using the Adapter Box

By using an Adapter Box (*NFM0 ZAB2 VKK*) up to three flow velocity sensors (3-path-measurement) as well as the level sensors mentioned in chap. "25.2.1 Connecting Sensors directly to NivuFlow Mobile" can be connected to the NivuFlow Mobile 750.

In such a case, two of three v-sensors are connected to the Adapter Box (Fig. 25-4) and the third sensor is connected directly to the NivuFlow Mobile 750 transmitter as shown in Fig. 25-1 through socket v1. An i-Series/NivuBar Plus level sensor is connected to the Multi I/O socket as depicted in Fig. 25-3.

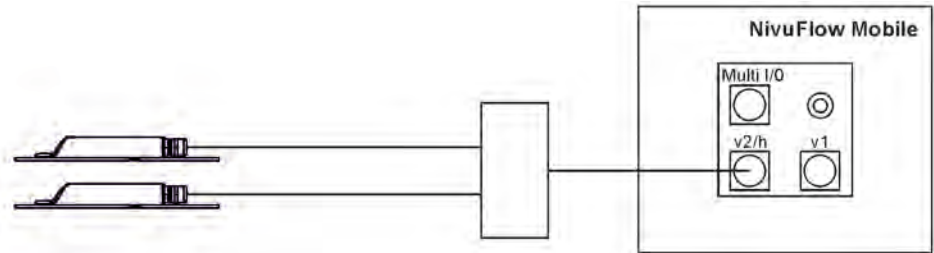

Fig. 25-4 Connecting two flow velocity sensors via the Adapter Box

25.3 Overvoltage Protection Measures

To protect NivuFlow Mobile effectively if operated from external power supply it is necessary to protect the unit by using overvoltage protection equipment.

WARNING



Danger of explosion when operated with direct connection in Ex area

*Operate the unit **only out of Ex areas** using direct mains connection (e.g. mains plug adapter) or direct external power supply (e.g. solar power).*

Never do so within Ex areas.

If used with **mains plug adapter**, NIVUS recommend the types EnerPro 220Tr / 20kA or EnerPro 220Tr / 5kA (Fig. 25-5) in the mains side.

For **direct external power supply** using 12 V DC (e.g. solar power) the type DataPro 2x1 12V/12V-11 μ H-Tr(N) for non-Ex (Fig. 25-6) is recommended.

➡ See chapter "55 Accessories".

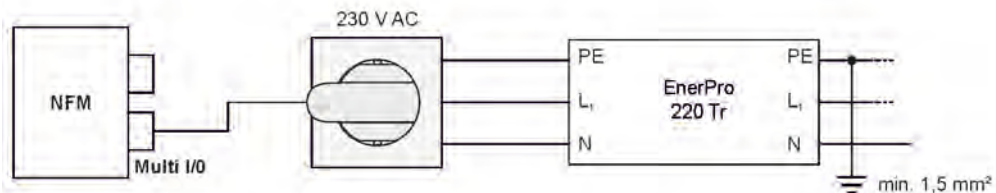

Fig. 25-5 General overvoltage protection for AC power supply

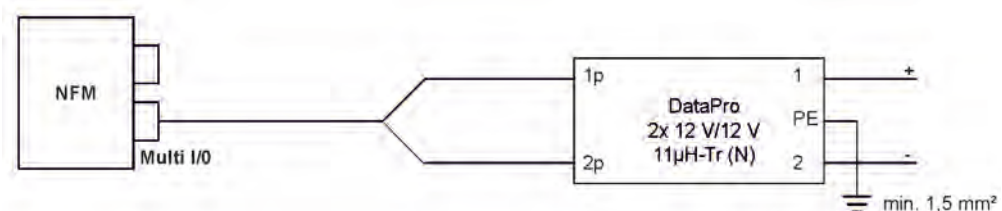

Fig. 25-6 General overvoltage protection for DC power supply

26 Single external Connection for Inputs/Outputs

If there is **one** additional sensor or actuator to be connected by using the inputs/outputs besides the sensors connected for flow velocity or level measurement, this can be done directly via the connection cables for the multifunction socket. Depending on the intended purpose there are different cable types available. All cables feature open cable ends on one side and a plug for the multifunction socket on the other side.

- ➡ For article numbers see chapter “55 Accessories”.
- ➡ For more than one external connection see chapter “27 Connecting the Connector Box for Inputs/Outputs”.

27 Connecting the Connector Box for Inputs/Outputs

A Connector Box (Fig. 27-1 no. 6) must be used if you wish to additionally connect **more than one** sensor or actuator using the inputs/outputs besides the flow velocity / level sensors on the NivuFlow Mobile 750 (Fig. 27-1 no. 1).

- ➡ For only one single external connection refer to chapter “26 Single external Connection for Inputs/Outputs”.



Important Note

The Connector Box can either be fastened directly on the NivuFlow Mobile by using the hoop guards (Fig. 27-1 no. 2) or can be put/fastened to any other place.



Fig. 27-1 NFM with Connector Box (example)

- ➡ How to fasten the Connector Box on the NivuFlow Mobile:
 1. Remove the rubber buffers (not depicted) from the reverse side of the NivuFlow Mobile (Fig. 27-1 no. 1). Both fastening plates (now loose, Fig. 27-1 no. 3) within the screw channels (Fig. 27-1 no. 4) and the rubber buffers are already required for the next step.
 2. Fasten the hoop guards (Fig. 27-1 no. 2) on the NivuFlow Mobile by using the rubber buffers.
 3. Fasten the Connector Box (Fig. 27-1 no. 6) on the hoop guards by using the accompanying screws.

4. Connect the sensors to the Connector Box. See terminal wiring diagram (Fig. 27-2).
5. Plug (Fig. 27-1 no. 5) the connection cable from the Connector Box into the multifunction socket on the NivuFlow Mobile.

➡ For article numbers see chapter “55 Accessories”.

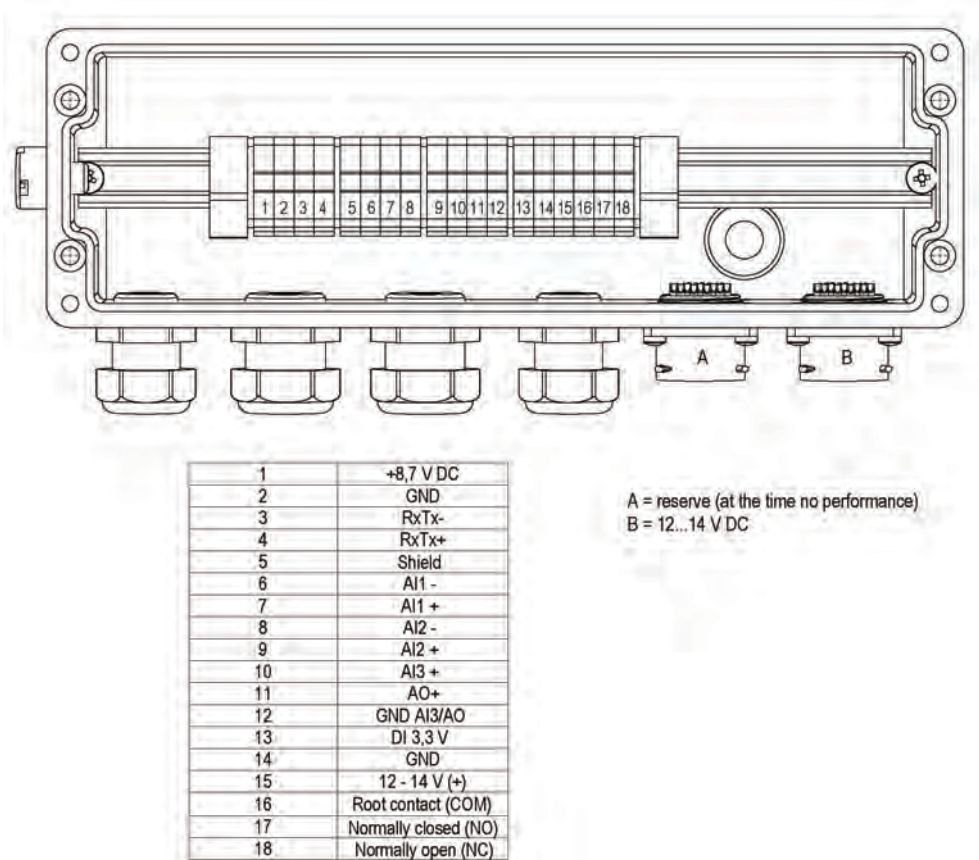

Fig. 27-2 Connector Box terminal wiring

Connection B on the Connectorbox is for external supply of the des NFM transmitter (12...14 V DC) with the Connectorbox plugged via the power adapter/battery charger (see chapter “23.1.2 Charging the rechargeable battery pack”) or the 2-wire connection cable (see chapter “23.1.3 Operation/Charging via an Alternative Power Supply”).

28 (T-Shape) Antenna for GPRS Data Remote Transmission

The accompanying T-Shape antenna is required for data remote transmission via GPRS.

➤ Installation and connection procedure:

1. Plug antenna cable into the socket on the unit (Fig. 28-1) and tighten the screw joint manually.

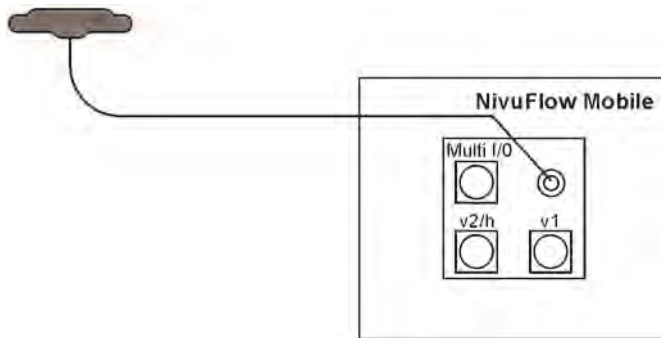

Fig. 28-1 Connection GPRS Antenna

2. Install the antenna at the highest possible position of the manhole or on the dust pan.
Note:
The T-Shape mobile communications antenna shall be installed in such a way that no persons are permanently (more than 6 minutes) present in a distance of less than 25 cm from the antenna.
As soon as the instrument operates correctly even shorter distances do normally not mean a danger to public health since the unit transmits only briefly on the mobile communications interface. As a precautionary measure this distance shall be complied with anyway.
3. If the unit is installed in a manhole close the manhole cover to verify that the data transmission works correctly even with the cover closed.
4. Set up a test connection using the communication parameter menu (see chapter "39 Parameter Menu Communication", >Modem state</>Test connection<) to verify data transmission. If the connection is poor change the antenna position until the data transmission is sufficient.

Putting into Operation

29 Notes to Users

Before connecting and operating the NivuFlow Mobile follow the instructions below.

This instruction manual contains any information required for the setting of parameters and the operation of the instrument. The manual is intended for technically qualified personnel. Appropriate knowledge in the areas of measurement system, automation technology, control engineering, information technology and wastewater hydraulics are prerequisites to put the NivuFlow Mobile into operation.

Carefully read this instruction manual in order to guarantee proper function of the NivuFlow Mobile. Connect the NivuFlow Mobile according to chapter "25.2 Sensor Connection".

In case of doubt regarding installation, connection or the setting of parameters contact our hotline:

- +49 (0) 7262 9191 955

General Principles

Do not put the system into operation before the installation has been completely finished and checked.

Follow the hints in the instruction manual to eliminate the risk of faulty or incorrect parameter settings. Get familiar with the transmitter operation before you begin to set the parameters.

After transmitter and sensors are connected (according to chapters "24 Sensor Installation in General" and "25 Installation of Sensors") the measurement place parameters can be set.

In most cases it is sufficient to set:

- shapes and dimensions of the measurement place
- sensors used and the according positions
- display units
- storage mode

The NivuFlow Mobile user surface is easy to understand. The basic settings can be easily adjusted by users themselves.

A startup wizard is available to facilitate the initial startup. The wizard will guide the user through the most important parameter settings in easy steps (see chapter "42 Parameter Menu Quick Start").

30 Indication System of Status LED on NivuFlow Mobile

The status LED (Fig. 30-1) on the front side of the NivuFlow Mobile follows a predetermined system which indicates the current status of the instrument.

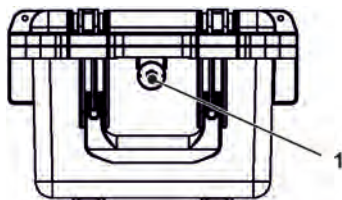

Fig. 30-1 LED on the NFM front

Once the NFM is in full working conditions without limitation the LED is lit **green**: 1x long, pause, 5x short.

The same intervals apply as soon as there is one error message pending at least. The LED then, however, is lit **red**.

Blue flashing in the pause between the first long flash and the five successive flashes indicates the number of users logged in: 1x for each user (max. number of possible users logged in is four).

➡ See also chap. “33 General Programming”.

The LED is lit in **white** while the system is booting e.g. after plugging in the rechargeable battery or after a firmware update.

➡ See also chap. “38.5.5 Update NivuFlow”.

31 Setting Up Connection

31.1 General

The NivuFlow Mobile is operated completely by using a standard smartphone/tablet or via notebook/PC. Use the preferred display and operation module according to the respective manufacturer specifications.

The following sections describe the connection setup procedures for Android, iOS and Windows.

31.2 Android Operating System

➡ Preparing the NivuFlow Mobile:

1. Ensure power supply: a minimum of one completely charged rechargeable battery pack either plugged into the instrument or alternatively connected via the multifunction socket (see chapter “23.1.3 Operation/Charging via an Alternative Power Supply”).
The following step “Wake-Up” can be skipped as soon as the battery pack is inserted now or when voltage is fed and the connection is set up within the following five minutes.
2. “Waking up” NivuFlow Mobile: hold the accompanying magnet (solenoid, Fig. 31-1 no. 2) to the reed contact (Fig. 31-1 no. 1; on front side of NFM) until the LED is lit.

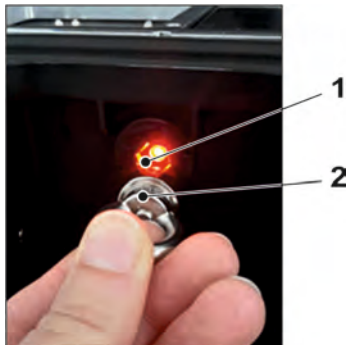

Fig. 31-1 Waking up the NivuFlow Mobile

➡ Steps on the display and operation module (smartphone, tablet, notebook, PC etc.):

1. Start the display and operation module.
2. Use the “Settings” symbol (Fig. 31-2 no. 1) to open the according menu.

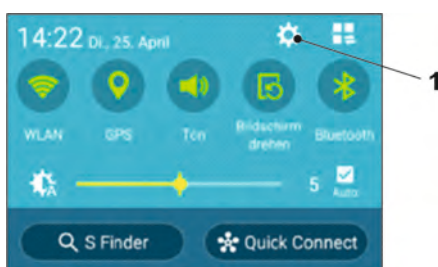

Fig. 31-2 Settings symbol

3. Select WLAN (Fig. 31-3 no. 1).

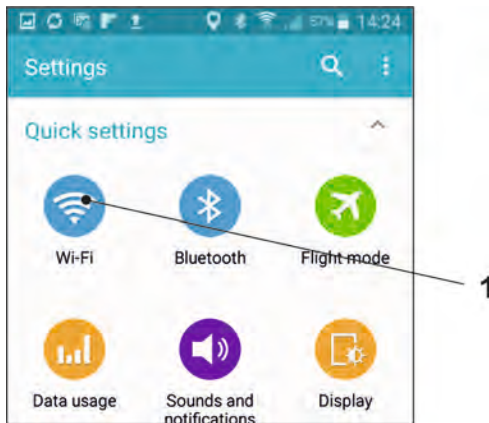

Fig. 31-3 WLAN symbol

4. From the list of available WLANs select the NFM (Fig. 31-4 no. 1) with the according SSID (default state = serial no.).

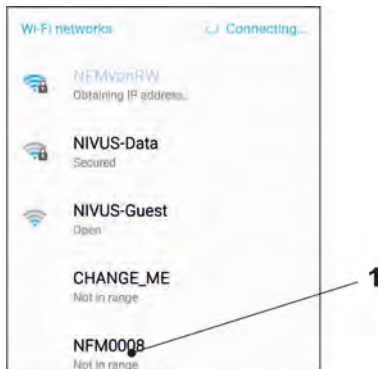

Fig. 31-4 WLAN List

5. Enter the password for server access (default state = PUK) (Fig. 31-5 no. 1) and connect (Fig. 31-5 no. 2).

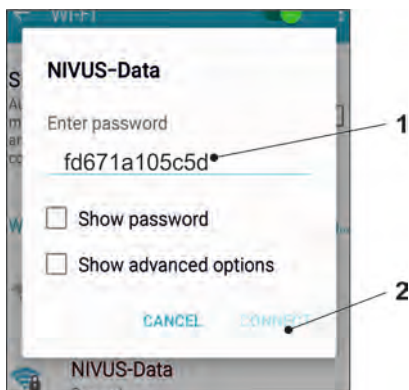

Fig. 31-5 Enter password (example here fd671a105c5d) and connect

6. Start the Internet browser.
7. Type "192.168.1.1" into the IP address field and open. The NivuFlow Mobile display (Fig. 31-6) is indicated as soon as the connection has been established successfully.

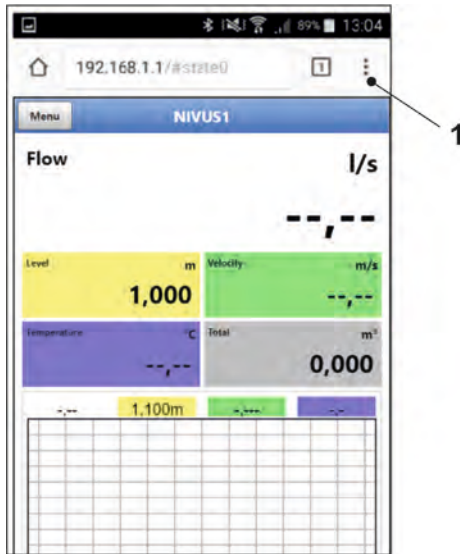

Fig. 31-6 NFM display in browser

8. To set a link on your “Home screen” (for direct access) use the “Tabs and Settings” symbol (Fig. 31-6 no. 1) and select “Add to Home screen” (Fig. 31-7 no. 1).

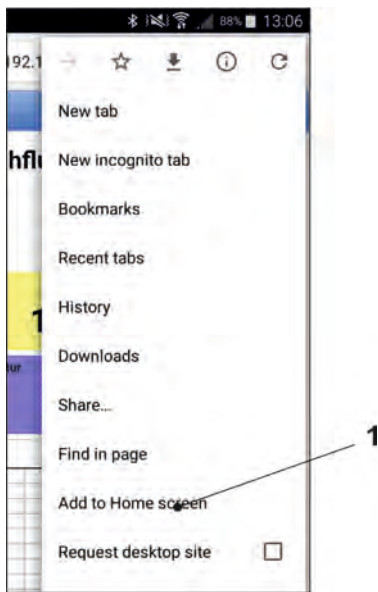

Fig. 31-7 Add to Home screen

9. Use “Add” to confirm (Fig. 31-8 no. 1).

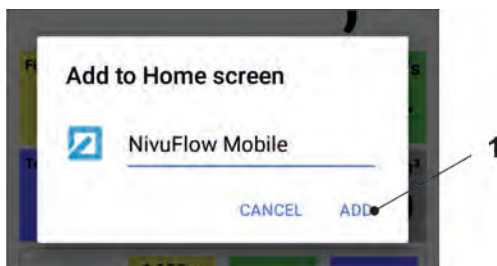

Fig. 31-8 Confirm adding

The link (Fig. 31-9 no. 1) is indicated on the tart screen and can be used for instant access without the need to specify the IP address.

This link can be used for each further NivuFlow Mobile transmitter after it has been selected from the WLAN list.



Fig. 31-9 Link in the start screen

31.3 iOS Operating System

🔄 Preparing the NivuFlow Mobile:

1. Ensure power supply: a minimum of one completely charged rechargeable battery pack either plugged into the instrument or alternatively connected via the multifunction socket (see chapter “23.1.3 Operation/Charging via an Alternative Power Supply”).
The following step “Wake-Up” can be skipped as soon as the battery pack is inserted now or when voltage is fed and the connection is set up within the following five minutes.
2. “Waking up” NivuFlow Mobile: hold the accompanying magnet (solenoid, Fig. 31-10 no. 2) to the reed contact (Fig. 31-10 no. 1; on front side of NFM) until the LED is lit.

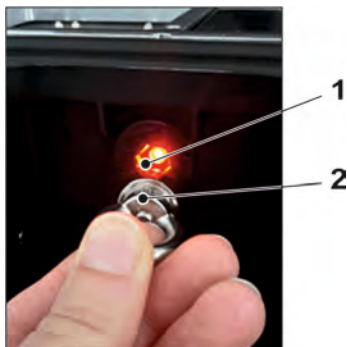

Fig. 31-10 Waking up the NivuFlow Mobile

🔄 Steps on the display and operation module (smartphone, tablet, notebook, PC etc.):

1. Start the display and operation module.
2. Use the “Settings” symbol (Fig. 31-11 no. 1) to open the according menu.



Fig. 31-11 Settings symbol

3. Select WLAN (Fig. 31-12 no. 1).



Fig. 31-12 WLAN symbol

4. From the list of available WLANs select the NFM (Fig. 31-13 no. 1) with the according SSID (default state = serial no.).

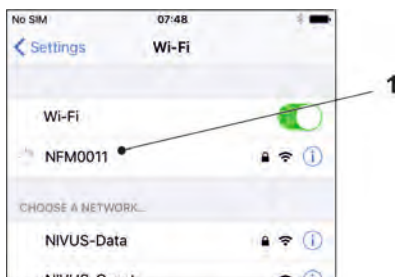

Fig. 31-13 WLAN List

5. Enter the password for server access (default state = PUK) (Fig. 31-14 no. 2) and join (Fig. 31-14 no. 1).



Fig. 31-14 Enter password and join

6. Start the Internet browser.
7. Type "192.168.1.1" into the IP address field and open. The NivuFlow Mobile display (Fig. 31-15) is indicated as soon as the connection has been established successfully.

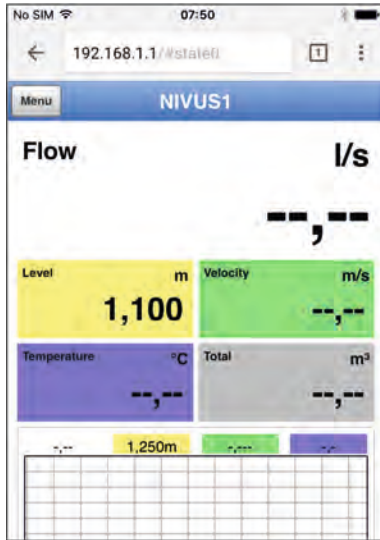

Fig. 31-15 NFM display in browser

8. Use the symbol "Provide" (Fig. 31-16 no. 1) to set up a link on your home screen (for direct access).

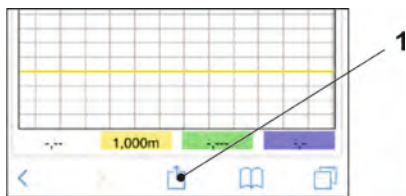

Fig. 31-16 Set up link

9. Select "To Home Screen" (Fig. 31-17 no. 1).

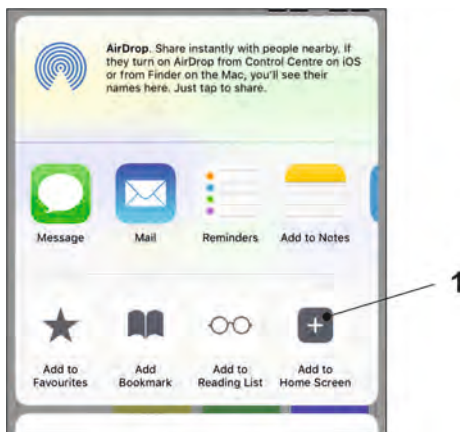

Fig. 31-17 To Home Screen

10. Confirm with "Return" (Fig. 31-18 no. 1).

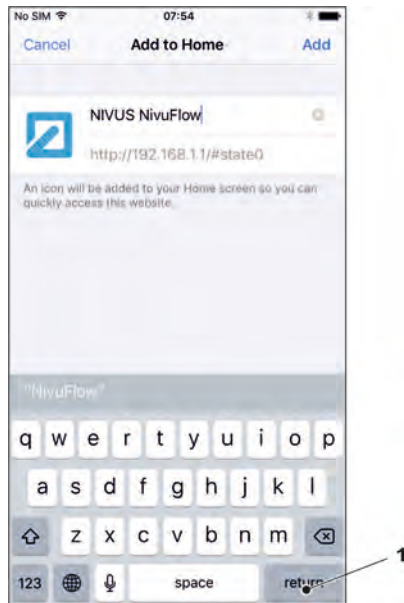

Fig. 31-18 Confirm adding

The link (Fig. 31-19 no. 1) is indicated on the start screen and can be used for instant access without the need to specify the IP address.

This link can be used for each further NivuFlow Mobile transmitter after it has been selected from the WLAN list.



Fig. 31-19 Link in the start screen

31.4 Windows Operating System

➡ Preparing the NivuFlow Mobile:

1. Ensure power supply: a minimum of one completely charged rechargeable battery pack either plugged into the instrument or alternatively connected via the multifunction socket (see chapter "23.1.3 Operation/Charging via an Alternative Power Supply").
The following step "Wake-Up" can be skipped as soon as the battery pack is inserted now or when voltage is fed and the connection is set up within the following five minutes.
2. "Waking up" NivuFlow Mobile: hold the accompanying magnet (solenoid, Fig. 31-20 no. 2) to the reed contact (Fig. 31-20 no. 1; front side of NFM) until the LED is lit.

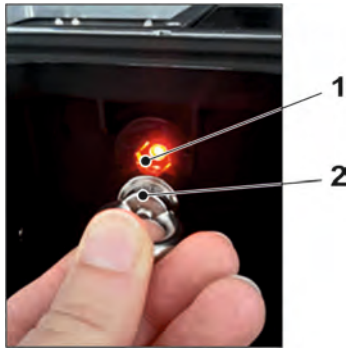

Fig. 31-20 Waking up the NivuFlow Mobile

- ➡ Steps on the display and operation module (smartphone, tablet, notebook, PC etc.):
1. Start the display and operation module.
 2. Go to the list of available (WLAN) networks (Fig. 31-21 no. 2).
 3. From the list select the NFM (Fig. 31-21 no. 1) with the according SSID (default stat = serial no.).



Fig. 31-21 List of (WLAN) networks (example)

4. Enter the security key (password) (default state = PUK; example here fd671a105c5d) (Fig. 31-22 no. 1) and connect.

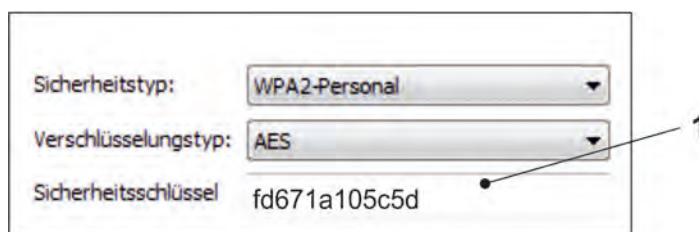

Fig. 31-22 Enter security key and connect

5. Start the Internet browser.

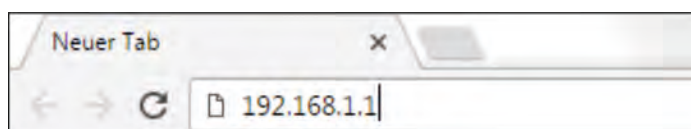

Fig. 31-23 Address field

6. Type "192.168.1.1" into the IP address field (Fig. 31-23) and open. The NivuFlow Mobile display (Fig. 31-24) is indicated as soon as the connection has been established successfully.



Fig. 31-24 NFM display in browser

7. To create a browser favourite (for direct access) click the "Favourites" star (Fig. 31-25 no. 1, example here Google Chrome) and confirm with "Finished" (Fig. 31-25 no. 2).

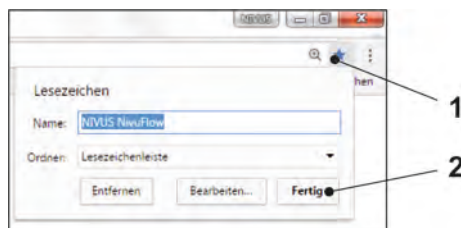

Fig. 31-25 Set up favourites

The bookmark is shown in the bookmarks list (Fig. 31-26 no. 1) and can be used for instant access without the need to specify the IP address.

This link can be used for each further NivuFlow Mobile transmitter after it has been selected from the WLAN list.

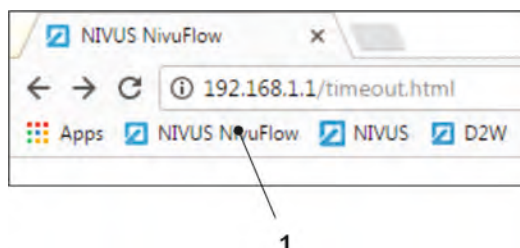
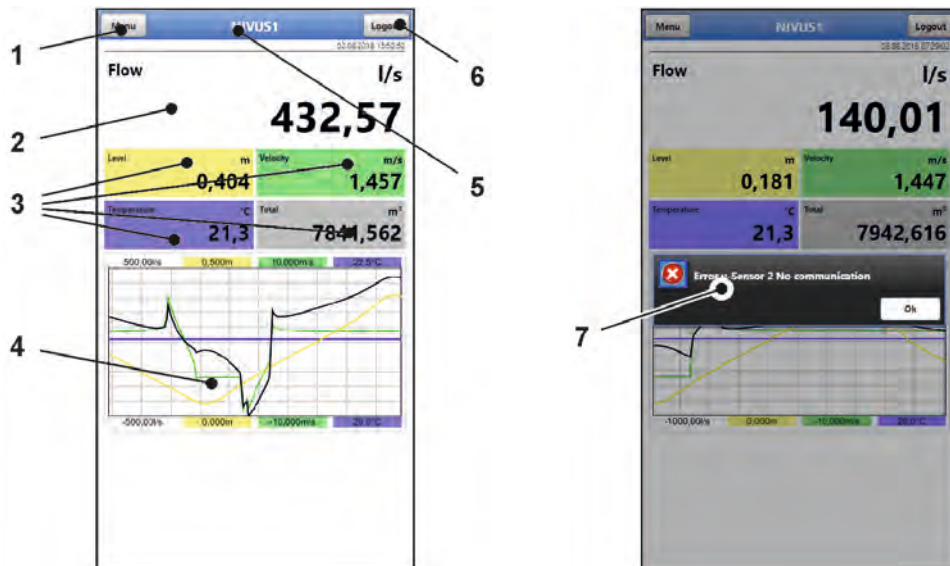

Fig. 31-26 Link in the bookmarks bar

32 Menu Operation/Overview

32.1 Display Overview

The NIVUS display at any time provides an overview on where you currently are within the menu structure and which entries you are about to modify.



- 1 Menu / Back (depending on display view)
- 2 Display area 1 (output field 1 for flow metering)
- 3 Display area 2 (output field 2...5 for level, average velocity, medium temperature and totaliser)
- 4 Display area 3 (trend graph on level, velocity, medium temperature and rate)
- 5 Name of measurement place
- 6 Logout (disconnection of display and operating module from transmitter; transmitter continues operation using the latest saved settings)
- 7 Possible error message, information or indication of active service mode (shown only once as separate window in the centre of the screen right after opening; close with "Ok")

Fig. 32-1 Display

32.2 Saving Parameters

After modifying parameters and navigating back using the menu field save the modified parameters to make the changes effective. Once saved the status message “Successful” (Fig. 32-2) is shown.

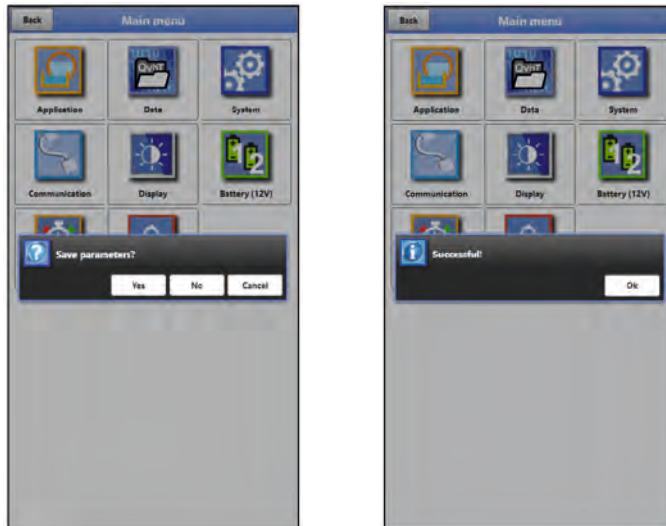

Fig. 32-2 Saving parameters

➡ For saving procedures see chapter “33.1 Save Parameters”.

32.3 Menus

All menus are described in chapter "Parameter Setting" as logical programming sequence starting at page 57.

The main menu contains seven basic menus which can be viewed and selected either by choosing the "Menu" field (from the main screen) or "Back" (from within the submenus).

The menus are:

Application	Guides the commissioning personnel through the entire setting of parameters for the dimensions of measurement places, selection of sensors, analog/digital inputs and outputs and diagnostics
Data	<ul style="list-style-type: none"> - Graphic representation of historic data on flow rate, level and (average) flow velocity - Indication of 24-hour day totals as tables - Saving of data - Saving and loading of parameters
System	<ul style="list-style-type: none"> - Basic information (serial no., version, article no. etc.) on the transmitter (required by the NIVUS GmbH in case of requests) - Language and date format settings under >Country Settings< - System time and time zone settings under >Time/Date< - Error messages under >Error Messages< - Service levels - Configuration of storage cycle - Parameter/System Reset - Instrument shutdown (powerdown) - Information on batteries and the current capacity
Communication	Parameters for the configuration of NivuFlow Mobile communication interfaces
Display	Output fields settings (text, decimal places etc...)
Battery (12V)	To choose the batteries/rechargeable used
Quick Start	Guided, quick parameter settings for simple measurement places
Alert	Activation of alarms in case of sensor errors and setting of high or low limit values/thresholds used to trigger alarms via e-mail using the NIVUS Web Portal

Table 5 Menu overview

Parameter Setting

33 General Programming

As a principle, modified parameters do not become effective before they have been saved. The instrument verifies whether parameters have been changed when you exit menus by using "Back". Finally, you will be prompted to eventually save modified parameters.

- >Yes<: modified parameters are accepted and saved.
- >No<: parameter modifications are rejected and the instrument will exit the menus.
- >Abort<: you will exit the prompt. Parameters remain to be modified, however will not become effective and will not be saved.



Tip to repeatedly measure the same measurement places

If certain measurement places are to be measured not only once, but again and again it is recommended to save the according parameter settings and readings (if required) on USB stick. This eliminates the need to readjust parameters for the next measurement at the respective measurement place by simply reloading the required data from the stick to the transmitter.

For more details see chapter "37.3 Data Memory" starting at page 99.

33.1 Save Parameters

Once all necessary (measurement place) parameters are specified, the data must be saved in order to become effective.

➡ Procedure:

1. Go "Back" three times: a window opens asking >Save Parameters?<. Confirm with >Yes< *.
The message "Successful!" indicates that the parameters have been saved.

* >Yes< saves the new parameters; >No< will abort the saving process leaving the last modified parameters active again; >Abort< will abort the saving process, the last modified parameters remain active and the initialisation process can be continued.

33.2 Change WLAN Password

The WLAN password is set to an individually determined ID **per default**. This ID can be found on a label on the top of the instrument (inside of the enclosure).

The default password can be changed as described below. The new password must have between 8 and 32 characters.

➡ Procedure:

1. Open the main menu with "Menu".
2. Open >Communication<.
3. Open the >WLAN< menu.
4. Select >Password<.
5. Enter the new password and confirm.

Up to four users may have access to transmitter and parameters simultaneously via WLAN. Simultaneous access will not be indicated or logged.

Necessarily observe to agree parameter changes in order to avoid several users accessing the parameters at the same time. Always the latest saving process applies.

**Store password in a safe place**

Never give the password to unauthorised persons.

If you need to note down the password always keep it in a safe place.

33.3 Change Instrument SSID

The SSID is set to the serial number of the instrument per default. The serial number can be found on the nameplate on the side of the enclosure.

The default SSID can be changed as described below. A new SSID must have between 8 and 32 characters.

➤ Procedure:

1. Open main menu via "Menu".
2. Open >Communication< menu.
3. Open >WLAN< menu.
4. Select >SSID< field.
5. Enter new name and confirm.

33.4 Lost Password

Each NivuFlow Mobile is shipped with an individual PUK ("Personal Unblocking Key" or Super-PIN) which permits to create a new password and to reactivate the instrument.

The PUK is identical to the default WLAN password and can be found on a label attached on the transmitter top (inside of enclosure).

➤ Procedure:

1. Open cover.
2. Loosen hexagon socket screws of battery compartment cover and remove the cover.
3. Remove the rechargeable batteries.
4. Hold the magnet to the reed contact and plug a battery simultaneously. The magnet must be held to the reed contact for at least 15 seconds until the LED flashes red several times. The NivuFlow Mobile is "woken up".
5. The WLAN list indicates the NFM with the default SSID (identical to the serial no. of the according instrument as specified on the nameplate).
6. Enter the default PUK as password.
7. Enter new password and, if required, SSID according to chapters "33.2 Change WLAN Password" and "33.3 Change Instrument SSID".
8. To accept the new password/the new SSID reinitialise the instrument by removing and reinserting the rechargeable batteries.
9. Activate the NFM within the next five minutes. Otherwise the modified password will not be accepted, the instrument will continue to use the default ID and will only respond to the default password.
10. Insert second battery if required.
11. Refit the battery compartment cover using the hexagon socket screws and close the cover.

33.5 Automatic Data Transmission to USB Stick

In standard situations data stored in the NivuFlow Mobile are transmitted to the display and operation module via WLAN.

➡ See chapter “37.3 Data Memory”.

If, in exceptional cases, this should not be possible e.g. due to the lack of WLAN, display and operation module malfunction or empty batteries, it is possible to read out the data memory automatically by using a plugged USB stick.



Using the USB interface is allowed only outside of Ex areas.

➡ Procedure:

1. Open enclosure.
2. Plug USB stick.
3. “Wake up” the NivuFlow Mobile with the magnet (solenoid).
The transmitter automatically transmits the entire content of the measurement data memory to the plugged USB stick as soon as no WLAN connection is available within 10 minutes. The status LED on the transmitter flashes green during transmission.
4. Data transmission is finished once the status LED has stopped flashing. The USB stick can then be removed.

34 Parameter Setting using Quick Start

This menu allows easy setting of parameters for elementary measurement places with the aid of default settings for various parameters.

➡ The >Quick Start< menu is described in greater detail in chapters “35.2.7 Menu – Quick Start” and “42 Parameter Menu Quick Start”.

➡ Procedure:

1. Open main menu.
2. Select >Quick Start< menu.
The query >Create new Measurement Place?< appears.

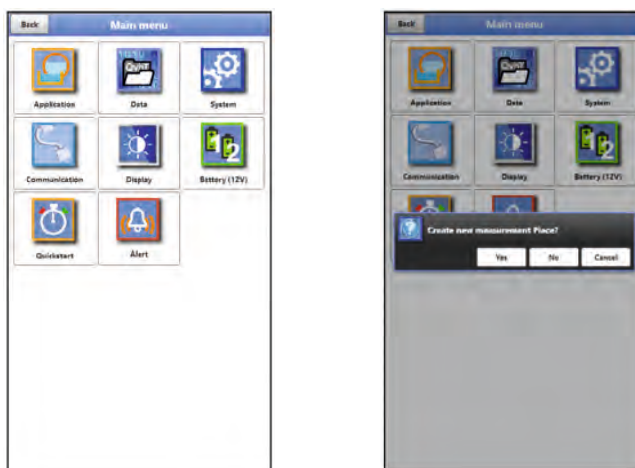

Fig. 34-1 Quick Start with query

3. Choosing >No< opens the >Region Settings< page of the >Quick Start< menu. Choosing >Yes< will ask >Are you sure? Old parameters and archive data will be lost!<. Selecting >Yes< here will erase the old parameters and archived data and indicates “Successful!” once the procedure is completed. >No< erases nothing and opens the >Region Settings< page.

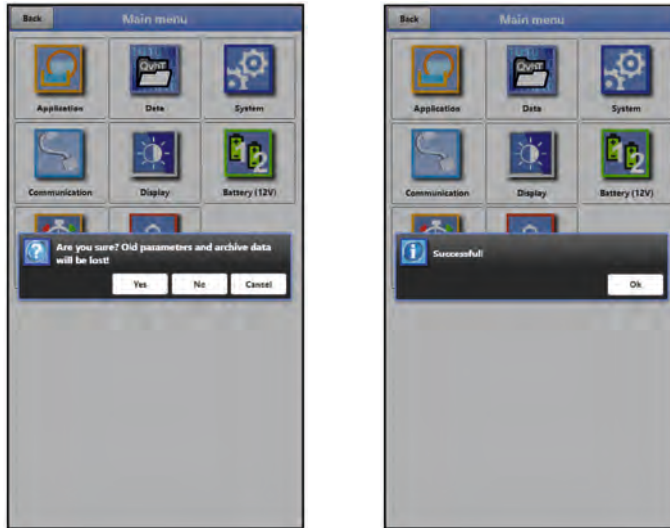

Fig. 34-2 Confirmation prompt “Erasing Parameters and Data”

4. On page >Region Settings< set the language, the date format, the required units and the storage mode (operating mode and storage cycle).



Fig. 34-3 >Country Settings< menu

5. Use the arrow keys to go to the next page >Measure Place<.
6. Set the measurement place parameters: specify name and channel profile including dimensions.

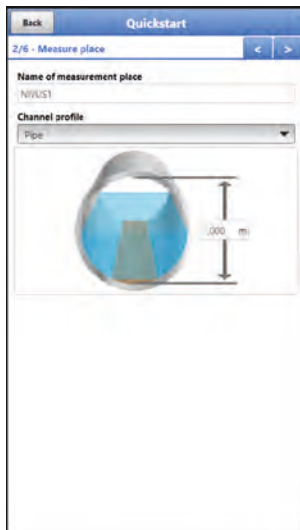

Fig. 34-4 >Measure place< menu

7. Use the arrow keys to go to the next page. You will be prompted to save parameters. Choosing >Yes< the saving process will be confirmed with the message "Successful!". Selecting "OK" opens the next page >h-Sensors<. >No< will not save anything and takes you to the next page >h-Sensors<. >Abort< remains the current page >Measure Place< open enabling to continue the setting of parameters here.
8. On page >h-Sensors< select the level sensors and set the parameters accordingly.



Fig. 34-5 >h-Sensors< menu

9. Use the arrow keys to go to the next page. Set the parameters for v-sensors 1...3 here and on the subsequent pages: select the type used or choose automatic sensor detection and enter all relevant data regarding >Mounting< or >v-determination low levels<.



Fig. 34-6 >v-Sensors< menu

10. Use “Back” to return to the main menu: you will be prompted to save parameters. Choosing >Yes< the saving process will be confirmed with the message “Successful!”. Selecting “OK” opens the main menu. >No< will not save anything and takes you to the main menu. >Abort< remains the current page >v-Sensors< open enabling to continue the setting of parameters here.
11. Use “Back” once more to go to the main screen.

35 Parameter Functions

35.1 Main Menu

The NivuFlow Mobile 750 parameters can be set using a total of seven menus which are described in greater detail starting with chapter “36 Application Parameters Menu”. The main menu indicates seven icons containing the functions described in the following chapters:



Fig. 35-1 Overview Main Menu

35.2 Functions of the first Menu Level

35.2.1 Menu - Application

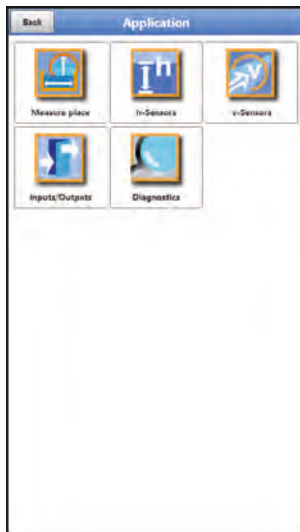

Fig. 35-2 Menu Application

This is one of the most relevant basic menus when it comes to setting parameters. The Application Menu contains five sub-menus where shapes and dimensions of measurement places can be set. It is used to define the flow velocity/level sensors as well as to set mounting position data.

Moreover the required analog and digital inputs and outputs can be defined here:

- Functions
- Measurement ranges
- Measurement spans
- Limit values

This menu includes diagnostic options for:

- Flow velocity and level sensors
- Inputs and Outputs
- Flow profile
- Signal analysis
- Simulation

Use this menu to enter or change:

- Constant, fixed sludge levels
- Low flow suppression
- Damping and signal evaluation and signal output
- Stability of signal evaluation and signal output

35.2.2 Menu - Data



Fig. 35-3 Menu Data

The data menu contains all internal stored measurement values. Following functions are available:

- Graphic representation of measurement values
- List of the 100 latest 24h day totals
- Communication and transmitting option of internal data
- Transfer of adjusted parameters to and from USB stick
- Options to set and to erase the internal data memory

35.2.3 Menu - System



Fig. 35-4 Menu System

This menu contains information on the transmitter:

- Firmware version
- Article number
- Serial number
- Information on battery voltage and credits/licenses

The following settings can be adjusted additionally:

- Language
- Units
- Date and time correction
- Read active error messages
- Erase error memory
- Configure storage cycle
- Parameter/system reset
- Instrument shutdown (Powerdown)

35.2.4 Menu - Communication



Fig. 35-5 Menu Communication

This menu includes settings required for communication with other systems:

- WLAN
- GPRS

35.2.5 Menu - Display



Fig. 35-6 Menu Display

This menu defines the five display fields of the main screen.

35.2.6 Menu - Battery (12V)

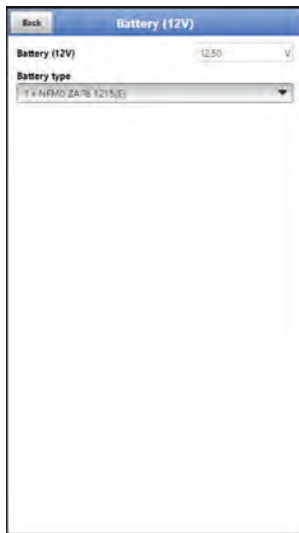

Fig. 35-7 Menu Battery (12V)

This menu is used to choose type and number of the batteries used.



Correct Capacity Indication

The capacity indication in the >System< / >Information< menu works reliably only as long as completely charged batteries are used and the type and number of the batteries used are specified here.

35.2.7 Menu – Quick Start

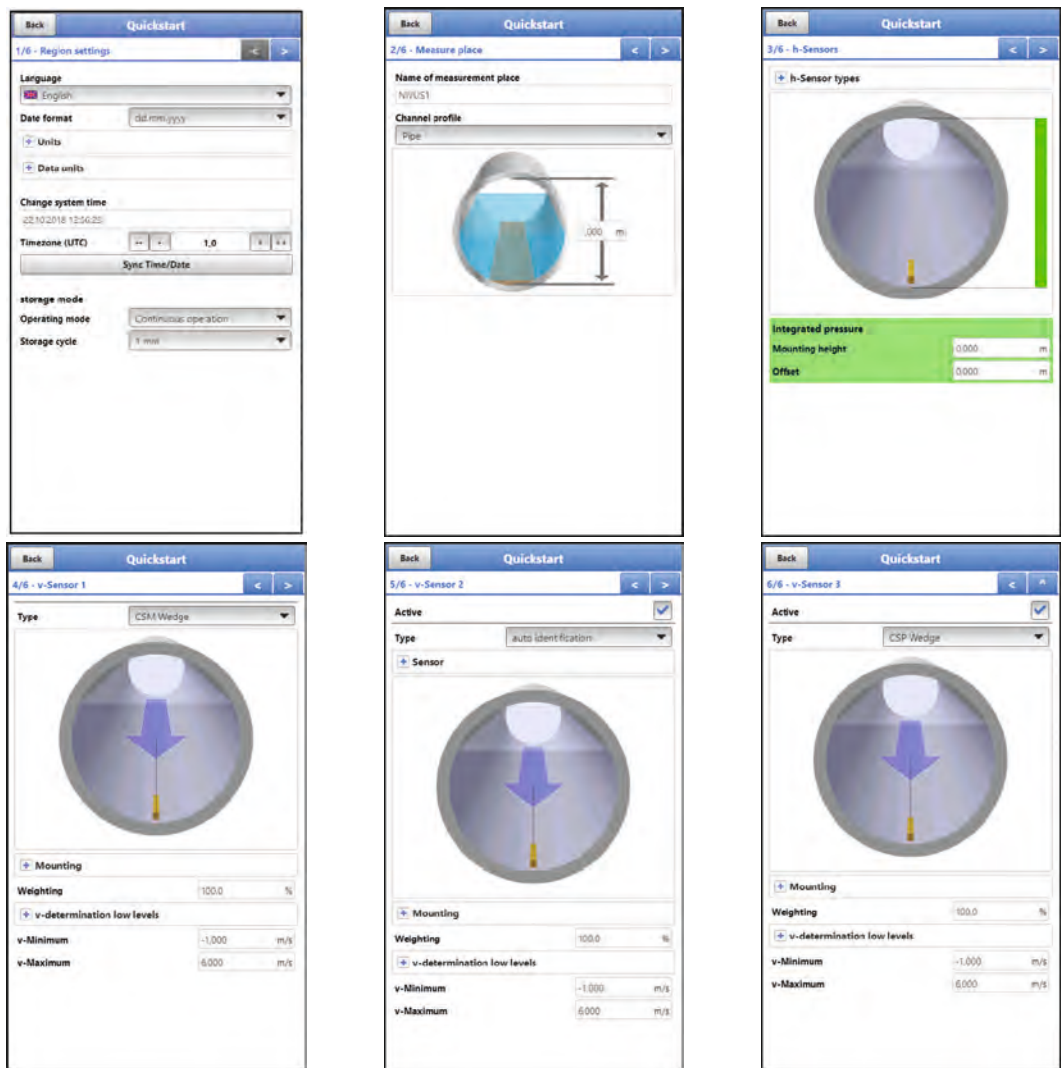

Fig. 35-8 Menu Quick Start 1...6

This menu allows easy setting of parameters for elementary measurement places with the aid of default settings for various parameters.

Depending on the number of the connected v-Sensors the >Quick Start< menu includes four to six pages:

- Page 1 >Region Settings<
- Page 2 >Measure place<
- Page 3 >h-Sensors<
- Page 4 >v-Sensor 1<
- Page 5 >v-Sensor 2<
- Page 6 >v-Sensor 3<

35.2.8 Menu – Alert

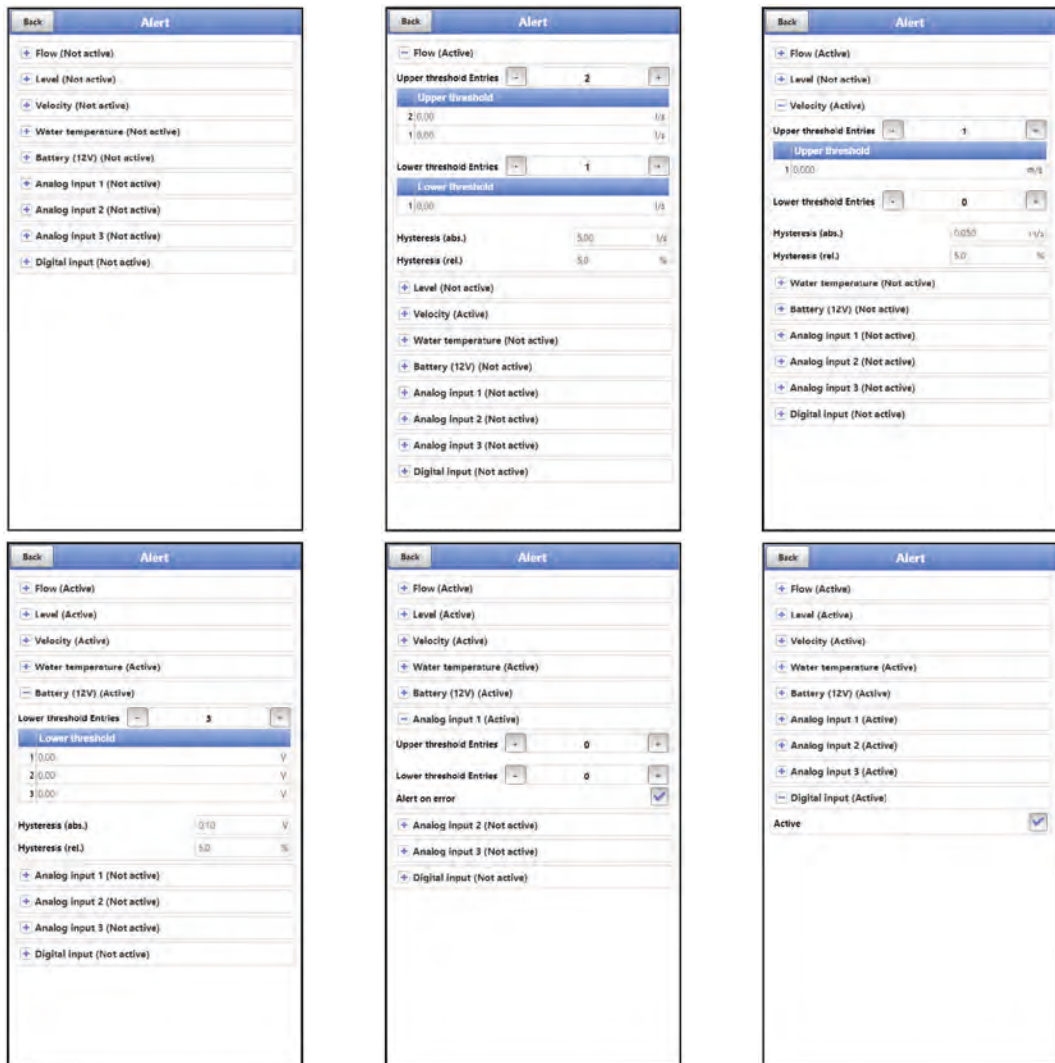

Fig. 35-9 Menu Alert

The Alarm menu comprises up to nine subsections depending on the parameter settings of the transmitter: >Flow<, >Level<, >Velocity<, >Water temperature<, >Battery (12V)<, >Analog input 1<, >Analog input 2<, >Analog input 3< and >Digital input<.

Here you can set the high or low limit values/thresholds and error messages the measurement transmitter will use to send alerting e-mails to pre-set e-mail addresses via the NIVUS Web Portal.

36 Application Parameters Menu

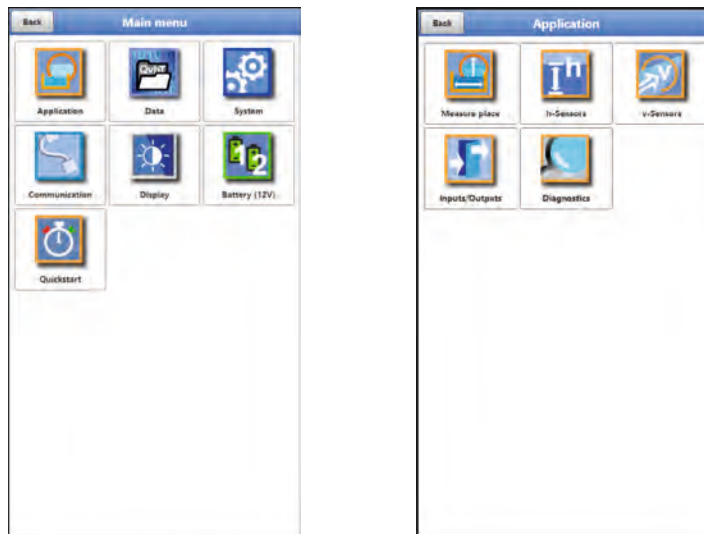

Fig. 36-1 Application Menu

The following sections describe the general parameter setting procedures.

36.1 Menu Measure Place

The >Measure Place< submenu is one of the most relevant basic menus when it comes to setting parameters.

The parameter set of a measurement place contains basic settings for:

- Name of measurement place
- Type and dimensions of channel profile
- Possible solid sediments settings (sludge level)
- Low-flow suppression
- Measurement damping and stability

36.1.1 Name of Measurement Place

This is where you can set the name of the measurement place.

Default setting: "NIVUS1".

The default name is deleted automatically as soon as the first character of the new measurement place name is entered.

- ➡ Type the desired name of the measurement place into the text field and confirm with "Enter". The name will be accepted and is shown in the main screen.

36.1.2 Channel Profiles

The transmitter allows selecting from a wide variety of standardised channel profiles mainly used in practice.

Since particularly older channel systems often have special shapes, the transformer moreover provides the option to enter dimensions or heights/areas of symmetric and asymmetric channels in tables.

The profile chosen is shown as graph in the 3D preview box if selected. To indicate the graph the dimensions entered are set in relation to one another.

This visual control is important to instantly see whether the profile has been basically created correctly. Particularly for free profiles this kind of direct verification is helpful.



Fig. 36-2 Selectable channel profiles

- Select from the available channel profiles:
 - Pipe
 - Ellipse
 - Egg profile (1:1.5)
 - Rectangle
 - Pipe Profiler
 - U-Profile
 - Trapezoid
 - Channel
 - Height-Width (sym.)
 - Height-Width (asym.)
 - Height-Area
 - $Q=f(h)$

- After choosing the profile, enter the dimension values digit by digit. Observe the measuring unit (decimal place).
Default setting: channel profile dimensions in METER.

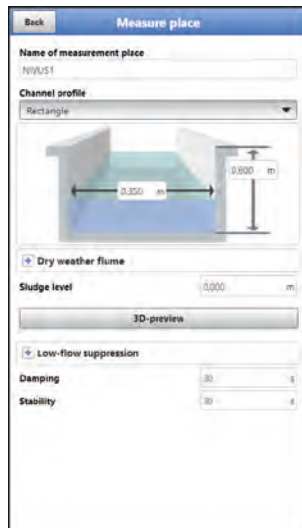

Fig. 36-3 Example of a channel profile menu

Pipe

This selection is suitable for round pipes, however can be used for half shells featuring a filling level of 50 % max. as well.

Deformed pipes featuring asymmetric height/width ratio can be set using the ellipsoid geometry selection.

For U-profiles there is an extra selection available.

Ellipse

Ellipsoid profiles can be found mainly in pipes subject to mechanical loads (lateral pressure or crown pressure). There are also special channel shapes known as ellipsoid profiles.



Ellipsoid profiles versus Egg profile

Symmetric ellipsoid profiles should not be confused with ovoid profiles (egg-shaped).

Ovoid profiles feature different radii in bottom and crown which makes them symmetrical only in a vertical sense.



Enter both dimensions of the ellipsoid profile.

Egg profile (Ovoid; 1:1.5)

This channel shape is a “standard egg shape” according to German DWA A 110 featuring a width/height ratio of 1:1.5. Squeezed or shrunk ovoid profiles need to be set using a free profile.

When setting the egg profile parameters only the maximum channel width needs to be entered. The transmitter calculates the height automatically by using the fixed 1:1.5 ratio.

Rectangle

This selection can be used to set the parameters of channels featuring vertical walls and a horizontal bottom. The parameters can be easily set by merely entering width and height of the channel.

The menu moreover includes the option to set the parameters for channels with a centre dry weather flume.

- Rectangle with dry weather flume



Procedure:

1. Select the dry weather flume.

2. Check the >Active< box.
3. Two more input fields will open.
4. Specify height and diameter of the dry weather flume.
5. Use the 3D-view to verify whether dimensions are specified correctly.

Pipe Profiler

The NIVUS Pipe Profiler NPP always defines this profile as full filled pipe. The transmitter reads the parameters such as inside diameter and correction factors automatically.

U-Profile

The U-profile is composed from a bottom semicircle and vertical walls. The semicircle radius here is $\frac{1}{2}$ the channel width and is entered automatically by the system.

Profiles with radii larger than $\frac{1}{2} \times$ channel width should be created as free profiles.

Trapezoid

This selection allows setting the parameters for symmetric channels featuring a horizontal bottom and sloped walls. Parameters of symmetric channels with a horizontal bottom, sloped walls and featuring vertical walls at the top can be set in this menu too.

Right as with rectangular profiles, a dry weather flume can be added as extra option.

- Trapezoid with dry weather flume
- ➡ Proceed as described in the rectangle with dry weather flume section on page 71.

Channel



Sound Expert Knowledge required

Setting the parameters for a water bed requires sound knowledge and comprehensive experience on the operation of the NivuFlow Mobile as well as about hydrologic ambient conditions.

We recommend letting the NIVUS commissioning service or a company authorised by NIVUS do the programming works.

In this profile you define the reference point/zero point yourself. Mostly, the maximum level or the water surface on one bank or channel side is determined as zero point. By performing local measurements on site you can save the profile of a certain section of the water body in the transmitter here.

- ➡ Enter the freely defined measuring section into the table one after the other.

Symmetric profile using height-width (Height-Width (sym.))

This menu can be used to set any kind of symmetric profiles.

Selecting the button >Table< indicates a table of values where a maximum of 32 breakpoint pairs (channel height/channel width) can be entered. The system calculates these values automatically and saves them as symmetric profile in the internal memory.

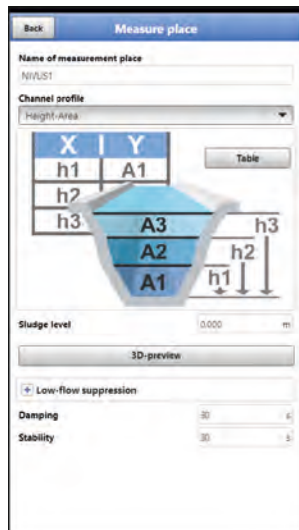

Fig. 36-4 Setting of profile using height-width (sym.)



Drawing required

A true to scale drawing is required to set the channel parameters.

Procedure:

1. Draw a vertical auxiliary line onto the drawing in the channel centre.
2. Then draw horizontal auxiliary lines on the distinct points where the profile changes.
3. Measure the length of the auxiliary lines and subsequently convert the length true to scale.
4. Start at level "0" to define the starting point of the channel.
5. Enter height and width of all other breakpoints "freely".
The distance between individual height breakpoints may vary. Not all of the 32 breakpoints need to be necessarily entered in order to define the profile since the transmitter linearises between individual breakpoints.
In case of large irregular changes of the channel dimensions select a lower distance between breakpoints in this section.
A proportional graph of the values is indicated after the channel parameters have been set.
6. Use the 3D view to verify whether the dimensions are specified correctly.
Thanks to this visual aid, bad programming issues can be visualised and corrected directly if required.

Free asymmetric height-width profile (Height-Width (asym.))

In practice asymmetric profiles with unusual shapes can be found occasionally. This is where the programming options for asymmetric profiles are used.



Note on the viewing direction with free profiles

The viewing direction >Width left< or >Width right< is opposite to the flow direction in the channel.



Drawing required

A true to scale drawing is required to set the channel parameters.

➔ Procedure:

1. Draw a vertical auxiliary line onto the drawing from the lowest point of the channel to the top.
2. Starting at this line, draw horizontal auxiliary lines from the distinct points of profile changes to the left and to the right.
3. Measure the distances of each of these auxiliary lines starting at the centre auxiliary line to the right and to the left.
4. Convert the results true to scale and enter the breakpoints into the 3 value columns as follows:
height / width to the left / width to the right
Necessarily observe here the relevant note above on the **viewing direction** with free profiles on page 73.
5. Start at level "0" to define the starting point of the channel.
6. Enter all other breakpoints "freely". A maximum of 32 breakpoints can be entered.
The distance between individual height breakpoints may vary. Not all of the 32 breakpoints need to be necessarily entered in order to define the profile since the transmitter linearises between individual breakpoints.
In case of large irregular changes of the channel dimensions select a lower distance between breakpoints in this section.
A proportional graph of the values is indicated here too after the channel parameters have been set.
7. Use the 3D view to verify whether the dimensions are specified correctly.
Thanks to this visual aid, bad programming issues can be visualised and corrected directly if required.

Free symmetric height-area profile (Height-Area)

Some hydraulic tables may contain height-area value pairs instead of height-width to specify symmetric channels. In such cases enter the value pairs into the selected height-area table.

Necessarily observe here the relevant note above on the **viewing direction** with free profiles on page 73.

The following procedure is the same as with programming height-width profiles. The programmed profile however cannot be indicated as graph here.

Q/h-Function ($Q=f(h)$)

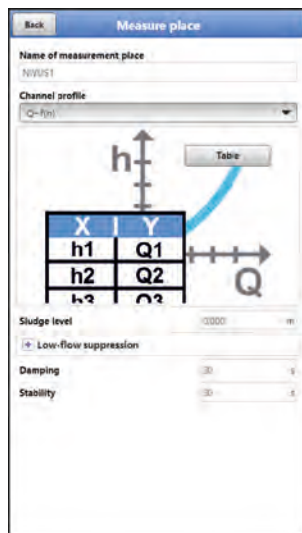

Fig. 36-5 Q/h-Function

This function significantly varies from the functions described above.

The selection is neither considering the channel profile nor the flow velocity and the **communication** with flow velocity sensors which may be connected is **disabled**. The missing flow velocity values will not be considered to create possible error diagnostics.

The system exclusively operates a Q/h-function. This means that a defined flow rate depending on the currently measured level is indicated. This value is entered into a value table depending on the height.

This table can hold a maximum of 32 height-related breakpoints. The transmitter linearises between individual breakpoints.

36.1.3 Sludge Level

Depending on measurement medium and flow velocity horizontal pipelines may tend to sedimentation on the pipe bottom.

The >Sludge Level< parameter permits to specify a certain sedimentation level within the pipe. The sedimentation is then considered as non-moving partial area on the channel bottom with horizontal surface. Prior to computing the flow rate this level height is subtracted from the wetted hydraulic total area.

36.1.4 3D-View

The 3D-view shows the measurement place featuring all adjusted parameters and the according sensors.

36.1.5 Low-Flow Suppression

This parameter is used to suppress lowest movements or apparent flow rates. The main area of use is the measurement of discharge volumes in permanently filled constructions.

☑ Check >Active<.

Another input mask opens up. Here you can specify which positive values you wish to suppress e.g. at very low flow rates. It is not possible to enter negative values.

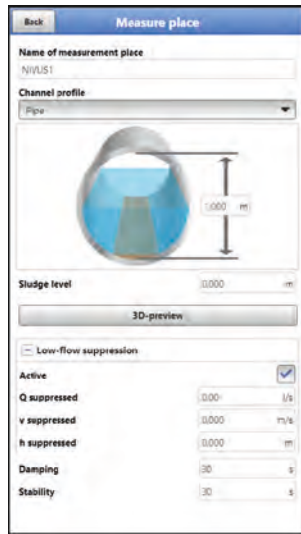

Fig. 36-6 Low-flow suppression

This parameter is to suppress lowest movement or apparent flow rates. The main area of use is the measurement of overflow volumes in buildings with permanent dam-up.

Lower flow velocities than the value specified here will be “suppressed” and hence no flow rate is indicated. The transmitter does not save any values.

>Q suppressed<



Enter the flow rate as positive value.

Negative values are not possible. The specified value is considered as absolute value and is effective in both positive and negative directions.

The measurement system will automatically reset the readings to “0” if the values should be lower than the value specified here.

>v suppressed<

This parameter permits to suppress apparent flow rates in applications featuring large profiles and high levels. Very low velocity fluctuations may cause heavy apparent flow rate fluctuations over a long period which cannot be suppressed using the >Q suppressed< function.

The measurement system will automatically reset the readings to “0” should the flow velocities be lower than the value specified here.

This will set also the calculated volume to “0”.

Only positive values can be entered here. The specified value is considered as absolute value and is effective for both positive as well as for negative velocities.

>h suppressed<

Enter low limit values for levels here. If the real levels are lower than the value entered here, the system will set the measurement values automatically to “0”. No areas are calculated in such cases and flow rate calculations cannot be carried out.

36.1.6 Damping

This menu enables to adjust the display and analog output damping in seconds.

Damping relates to all level and flow velocity values which are available as input. It is not possible to select individual values and to damp single values in different ways.

Taking the specified period, all readings are saved and a floating average is created for each individual average value. This average is used for further calculation of the flow rate.

Input the value in steps of one second.

Default setting: 30 s

36.1.7 Stability

The stability parameter defines the period the transmitter bridges values without having valid measurement events (e.g. in case of invalid level or flow velocity readings) available.

During this period the NivuFlow Mobile operates using the latest valid reading. If the specified period is exceeded without detecting a correct value the transmitter goes back to reading "0" considering the damping set. The transmitter does not store the values.

Input the value in steps of one second.

Default setting: 30 s

36.2 Setting Parameters in Menu h-Sensors

After setting the measurement place parameters, the level sensor(s) shall be defined and the according measurement range(s) need to be determined.

The level sensor parameters can be set in the >h-sensors< submenu.

36.2.1 h-Sensor types



Fig. 36-7 Selection level sensor settings

You can find a choice of level sensors behind the button >h-Sensor types<.

- Open parameter >h-Sensor types< and select the type of sensor connected to the transmitter.
For the very most applications it is sufficient to select a level sensor.
- In case of using more than one level sensor (e.g. i-Sensor and 2-wire level) check one box for each sensor.



Sensor connected?

After finishing the parameter settings the missing or faulty programmed sensors are detected and the instrument issues an error message.

The number of the selected sensors is equal to the number of the individual level measurement sensors over the entire measurement cross section. Only one level sensor can provide a valid reading per measurement. The transmitter does not accept faulty and not reasonable combinations.

A maximum of three different level sensors can be selected.

Adjust the sensor measurement ranges underneath the channel graph.



Sensor detection

The transmitter does not recognise the type of 2-wire level sensor. Hence, the indication of the sensor in the display is not crucial for the measurement range.

As standard the transmitter indicates the 2-wire level sensor as ultrasonic sensor from the top.

Example:

Air-ultrasonic sensor on the top with beam direction from top down; pressure sensor and water-ultrasound on the channel bottom.

The level sensors are shown within the channel shape previously specified when setting the measurement place parameters.



Fig. 36-8 Level sensor selection

Select from the following level sensors:

- Integrated pressure**
 Level measurement from the bottom using a combi sensor with integrated pressure cell (Type V2D or V2U).
 Lateral installation possible, e.g. in case of sedimentation or high pollution loads.
 Level measurement possible even in case of impoundage.
- 2-wire level**
 The level is measured by using an external 2-wire sensor supplied by the transmitter.
 Example: pressure probe Type NivuBar Plus
 The use of 0/4...20 mA signal from external transmitters such as NivuMaster or Multi-Ranger can be enabled in this menu as well.
- i-Series sensor**
 Connection of NIVUS i-Series ultrasonic sensors on analog input AI 1.
- NIVUS air-ultrasound**
 The level is measured from the top down using an air-ultrasonic sensor Type DSM-L0.
 This sensor is used to measure low flow levels. The level sensor shall be installed exactly in the centre of the channel crown ($\pm 2^\circ$) parallel to the water surface.
- Integ. water-ultrasound**
 The level is measured from the bottom up with the Type CSP-V2H or CS2-V2U combi sensor using water ultrasound. This sensor type is appropriate for discharge detection in medium part filled areas. The combi sensor shall be installed exactly in the centre of the bottom (deviation $\pm 2^\circ$).
 The sensor however can be placed out of the centre in the event of sedimentation or

the risk of soiling. In this case water-ultrasound from the bottom up however must not be used since this may lead to measurement failure!
For such situations a different level sensor (ultrasound from top down or pressure cell) must be used.

- **Fixed value**
This option is conceived for permanently full pipes and channels. Such applications do not require level measurements. The measurement system in this case provides the constant filling level required for flow calculation.
This parameter can be used as supporting value for tests or for initial start-ups if level values are not available.

36.2.2 Define Measuring Ranges

Depending on type and number of the selected sensors a coloured bar is shown on the right-hand side of the channel profile graph. The colour of this bar indicates the individual sensor operating range.

- Measuring range
 - Top: red
 - Centre: yellow
 - Bottom: green
- Number of sensors used
 - only one: solid green bar
 - two: colour combination green/red

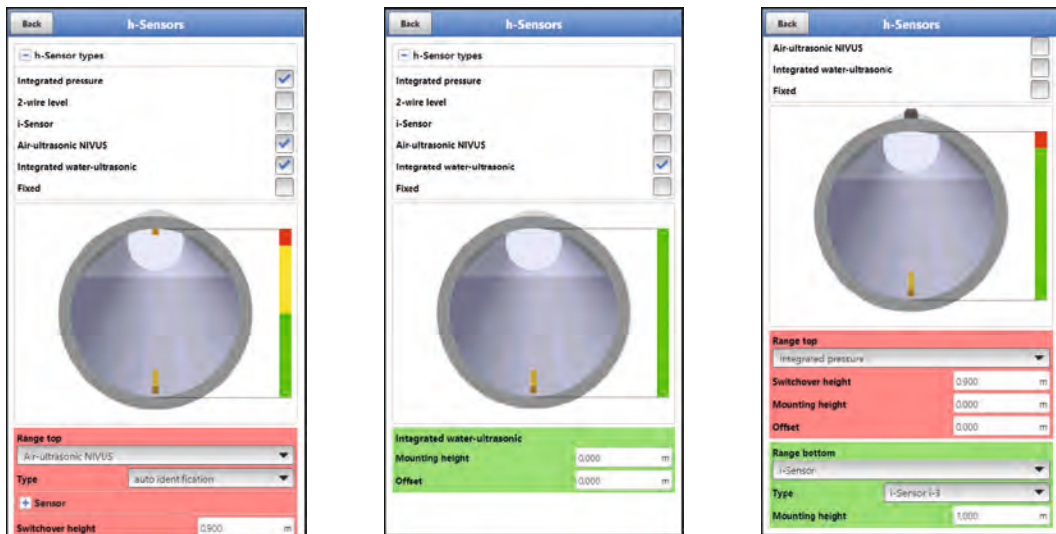

Fig. 36-9 Sensor selection and indication of sensor measuring ranges

Depending on type and number of the selected sensors 1...3 coloured programming sections are shown below the channel profile graph. The colours of this programming sections are equal to the colours of the sidebars and the according sensors.

- Measuring range
 - Top: red
 - Centre: yellow
 - Bottom: green

- Number of sensors used
 - only one: solid green area
 - two: colour combination green/red

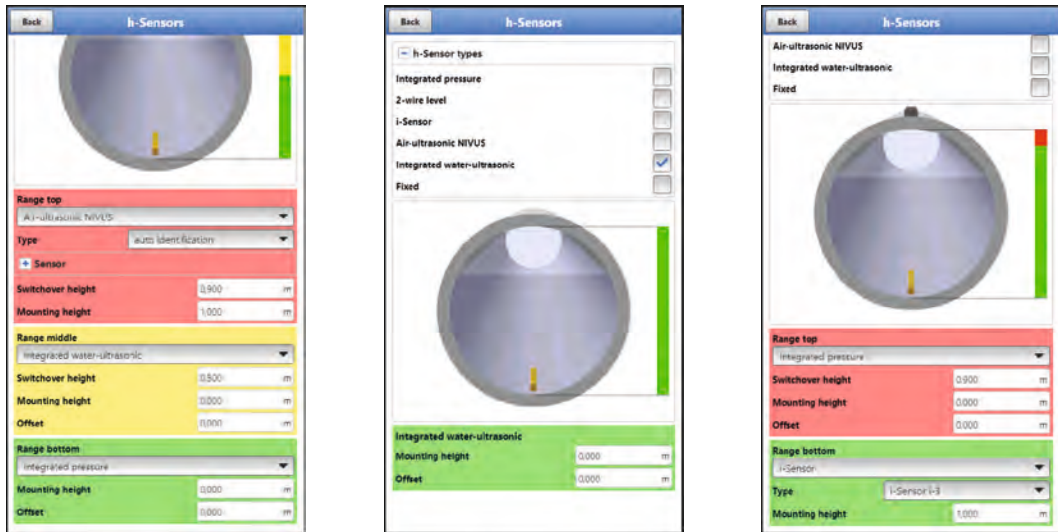

Fig. 36-10 Indication of programmable ranges

You can assign one level sensor to each programming section (see Fig. 36-8).
The transmitter will automatically assign the sensors to the appropriate programming sections.

The assignment depends on the channel shape set.

- NIVUS air-ultrasonic: Range bottom
- Integrated pressure: Range top
- etc.

This assignment can be configured individually. During this procedure only the previously selected sensors are indicated (see Fig. 36-8).

It is possible to use even one level sensor for 2 or 3 programming sections.

In such a case the other activated level measurement values are merely saved in the internal memory, however will not be used for calculation purposes.



Fig. 36-11 Level sensor assignment to programming section

The range of each programming section can be modified. To do so, change the respective >Switchover height< accordingly.



Specify positioning values accurately

Observe to accurately specify the positioning values of the individual sensors.

Sensors with built-in pressure measurement cell shall be installed at the lowest point of the channel bottom (sensor Type CSP-V2D, CSP-V2U and CSM-V1D).

If sensors should feature an elevated mounting position (block or similar) or should be installed on a berm, it is necessary to enter a different value as mounting height. Measure the distance from the **bottom edge** of the sensor mounting plate down to the lowest point of the application.

Then enter this value as >Mounting height<.

The **centre** of the sensor mounting plate is the reference value in the event of tilted or inclined sensors (such as lateral installation within pipes or trapezoid channels).

The sensor position value is accepted automatically for the position of the v-sensor as well as for the determination of v-crit (see chapter “36.3.5 v-Determination low levels”).

It is possible to additionally enter an offset to adjust the pressure sensors.



Fig. 36-12 Programming integrated pressure sensor

The same specifications apply for flow velocity sensors with integrated water-ultrasonic sensor. Measure the distance from the top edge of the sensor crystal.

The system automatically detects and considers these differences accordingly while connecting the sensors.

36.3 Setting Parameters in Menu v-Sensors

Apart from the measurement place and the level sensors, the third relevant point is setting the parameters of the flow velocity sensors. Except type and number of sensors this menu moreover includes the spatial position. The values specified within this menu relate to the defined channel regarding shape and spatial dimension (see chapter “36.1.2 Channel Profiles”).

36.3.1 Number of Flow velocity sensors

You can connect one flow velocity sensor to the NivuFlow Mobile 750 transmitter.

The option to connect up to three flow velocity sensors is currently not supported, however, in preparation.

36.3.2 Selecting the Sensor Types

Select between four different sensor types or automatic detection:

- CSM Wedge
- CSM Wedge + Press
- CSP Wedge
- CSM Pipe
- auto identification

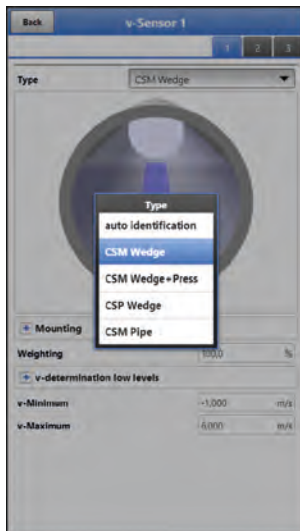

Fig. 36-13 v-Sensor selection

36.3.3 Sensor mounting position

Extra application parameters can be set for the installation of v-sensors.

These parameters are intended mainly for installation positions which vary from the default settings.

Option >Flush with wall< (only for channel profiles)

- Pipe
- Egg profile
- U profile

The parameters >Mounting height<, >Distance centre< and >Mounting angle<, which need to be adjusted to each other, can be entered here.

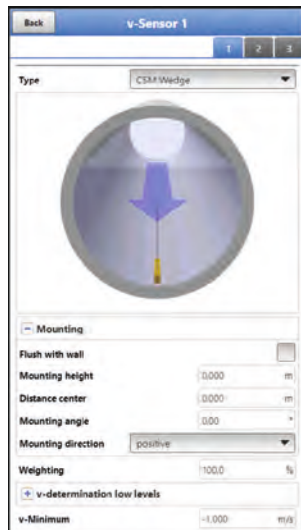

Fig. 36-14 Programming using height, distance and angle

For sensor **installation flush with wall** you can alternatively enter the angle of incidence only (1-parameter programming).

The parameter is used as soon as there are wedge sensors fastened directly on the wall of the slanted/bevelled area.

The use of the 1-parameter programming by entering the angle only requires an angle of incident directed to the centre of the circular profile or segment as well as the installation situations mentioned above. However this method significantly facilitates correct programming.

🔄 Procedure:

1. Tick the >Flush with wall< checkbox.
This reduces the number of input boxes. Only the >Mounting angle< box remains to be enabled.
2. Enter the sensor mounting angle.
3. Verify your input.
The graph now indicates the sensor showing the angle of incident entered.

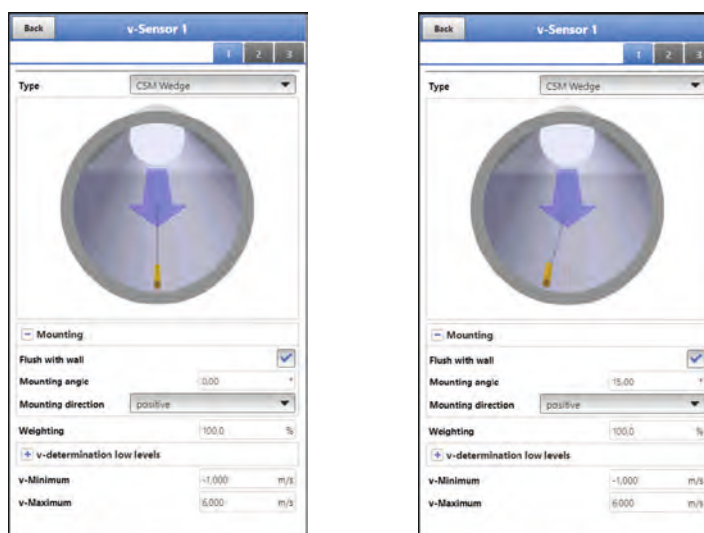

Fig. 36-15 Parameter setting only by entering the angle

Input box >Mounting height<

➡ Procedure:

1. Measure the distance between the bottom edge of the mounting plate (v-sensor) and the lowest point of the channel bottom.
2. Enter the measured distance in the >Mounting height< field.

Default setting: METER.

It is not necessary to enter a value as soon as the sensor is mounted directly on the ground at the lowest point of the channel.

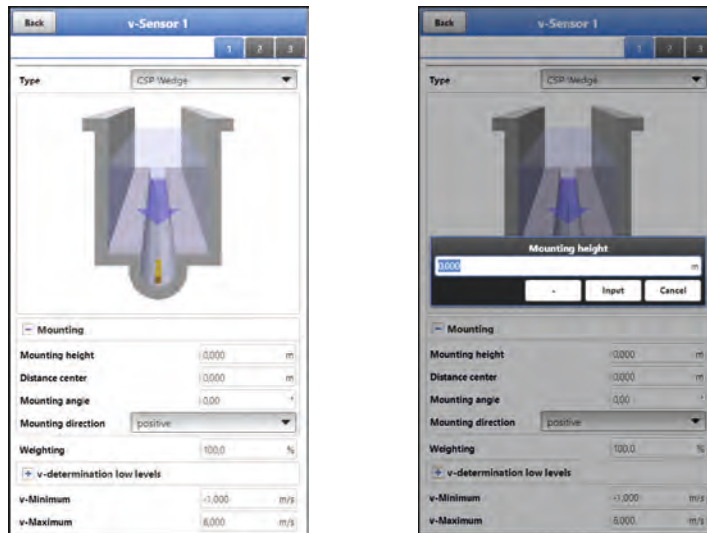

Fig. 36-16 Parameter setting mounting height

In structured channel profiles such as channels featuring a **dry weather flume** and a **berm**, the lowest point within the channel is equal to the zero point. The lowest point in this case is the bottom of the dry weather flume.

If sensors need to be installed at an elevated position using a block or similar due to the **risk of soiling or sedimentation**, this distance needs to be considered as well.

➡ Procedure:

1. Determine the sensor positions related to the 0-point of the application.
The reference point is the bottom edge of the mounting plate, with pipe sensors the horizontal area of the sensor head.
2. Enter the distance into the input field >Mounting height<.

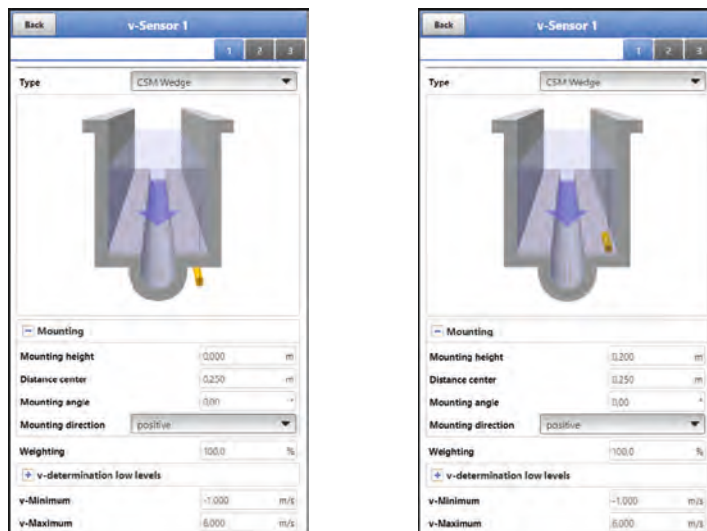

Fig. 36-17 v-Sensor height set too low and set correctly

Input field >Distance centre<



Observe the real direction of installation

Contrary to the usual point of view the user looks in the direction of flow, the v-sensors however look in the direction of the user.

While programming, observe that the real position is rotated by 180°.

The sensor parameters are set as follows:

- v-Sensor 1 is always in the centre position

The transmitters calculation procedures are based on the v-sensor installed in the channel centre.

If the v-sensor needs to be installed out of the centre the offset must be entered in >Distance centre<.

- Entering a negative value virtually moves the sensor to the left.
- Entering a positive value virtually moves the sensor to the right.

The value relates to the centre of the application.

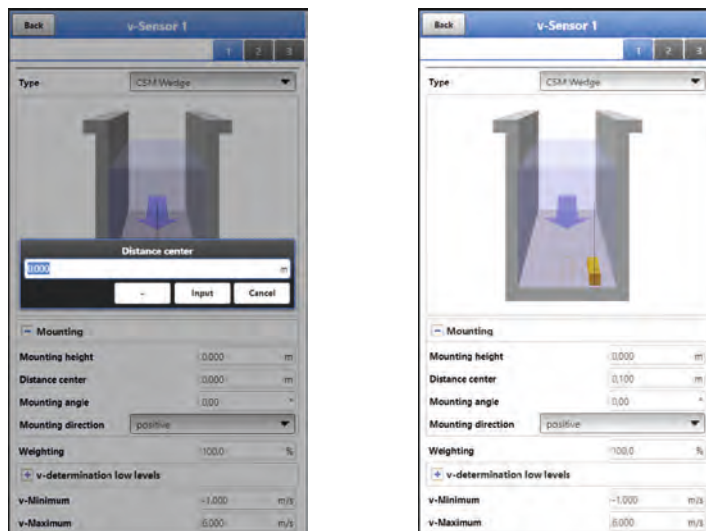

Fig. 36-18 Entering sensor position, in relation to the application centre

Input box >Mounting angle<

Default setting: v-Sensor always measures flow velocities vertically from the bottom up.

In some applications however it may be necessary to install the sensor in a sloped or even in a horizontal position:

- sloped on the inclined walls of a trapezoid channel
- lateral on channel walls
- in the round section of a pipe profile or an U-profile

In such a case the altered angles of incidence need to be entered in the transmitter. The vertical, upward beam of the ultrasonic signal is the reference point.

The slope of the **angle of incidence** is set opposite to the direction of flow as follows:

- negative value: slope to the left
- positive value: slope to the right
- 90°: horizontal beam
- 180°: downward beam

Mounting direction

This particular parameter is used only with special applications.

Default setting: The direction of sensor installation is always set to >positive< (measuring against the direction of flow).



Change the mounting direction only for special applications

Do not modify this parameter in normal operation and for standard applications.

Entering >negative< results in invalid flow velocity readings.



Fig. 36-19 Modifying the sensor mounting direction

36.3.4 Weighting

In the event of using several flow velocity sensors the relevance of each individual flow velocity sensor for the result of the average total velocity must be defined. Enter your value as a percentage in the >Weighting< box.

Default setting: 100 %.



Expert knowledge required

The weighting value depends on the application as well as the sensor position.

Such applications demand comprehensive knowledge on fluid mechanics and require NIVUS personnel or an authorised expert company.

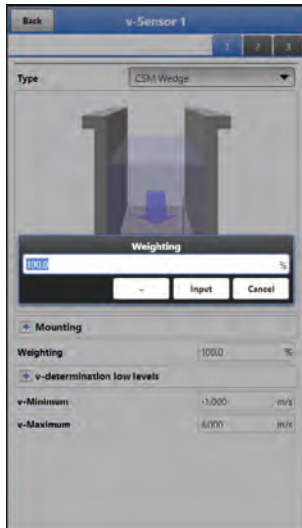

Fig. 36-20 Weighting v-sensor

36.3.5 v-Determination low levels

Due to constructional and physical reasons the flow velocity sensors cannot measure the flow velocity anymore below a certain minimum level. This minimal height is:

- Type CSM: 3 cm
- Type CSM-D: 5.5 cm
- Type CSP: 8 cm

Poor application conditions or an elevated sensor installation may push this level even higher. This level is referred to as **h-crit**.

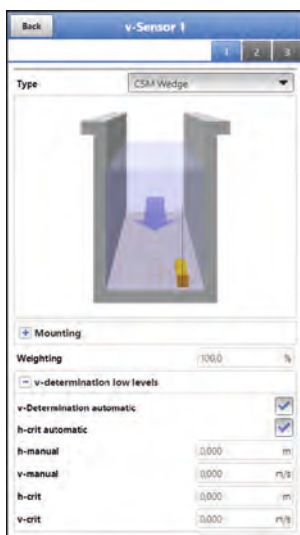

Fig. 36-21 Sub menu: v-determination low levels

The >v-determination low levels< menu facilitates the detection of temporary low flow volumes (such as discharges at night, infiltration water or similar).

A **requirement** for this function is:

- The application must be backwater-free.

Working principle:

As soon as the level falls significantly, from a certain point on it is not possible anymore to measure the flow velocity. The transmitter creates an internal table of v/h-readings at the point of the minimum level (h-crit) on which a flow velocity still can be measured. The system here uses the latest measurable flow velocity reading. The exponent of the channel shape set is considered automatically to calculate this curve.

As soon as no flow velocity can be recorded anymore, a level however is measured, the system automatically computes an "appropriate" flow velocity within this value table.

>v-Determination Automatic<

Default setting: Function activated (box checked).

- As soon as the level reaches h-crit (critical level), the latest measured flow velocity reading is saved automatically as a calculation basis for lower levels. This calculated flow velocity value then is used to compute the flow rate if the level continues to fall. Should the level first rise above h-crit and then fall below h-crit again, the newly determined velocity value is used as a calculation basis for the flow rate calculation to come.
- If >v-Determination Automatic< is disabled and the level should fall below h-crit, the system uses the flow velocity value set under v-manual to calculate the flow rate.
- Disable >v-Determination Automatic< box as soon as you expect very low flow levels and backwater within your channel.
- Deactivation makes sense too as soon as in the event of flow rate zero a small amount of the medium is supposed to stand still.
Set the value in >v-manual< to ZERO. The system then does not compute any flow rates at very low flow levels.

>h-crit automatic<

This automatic calculation method includes the specification of the sensor type and the mounting height parameters (see chapter "36.3.3 Sensor mounting position", Fig. 36-16).

The lowest possible level required to measure flow velocities is automatically determined by the transmitter. If this option is disabled the system utilises the value set in >h-manual< as h-crit.

Default setting: Function activated (box checked).

>h-manual<

This input box is used to manually enter the level. This level is related to the flow velocity value >v-manual<.

>h-manual< must not be lower than >h-crit< since otherwise readings might get lost.

Default setting: >h-manual< is set to "0".

>v-manual<

Use this input box to manually enter a flow velocity value.

This value is related to >h-manual<. The required flow velocity value for the according level can be computed e.g. by using hydrologic software.

>h-crit<

This input box is used for v/h-calculation. To do so, enter the level as from which the system is desired to utilise v/h-calculation.

>h-crit< is active only if >h-crit automatic< is disabled. Otherwise it will be indicated but cannot be selected.

The value entered in >h-crit< must not be higher than the value in >h-manual<.

>v-crit<

This menu is conceived for measurement in levels lower than >h-crit<. Falling below the minimum velocity, the system will switch over to a calculated value (according to Manning-Strickler).

36.3.6 Limitation of velocity evaluation

Adjusting >v-Minimum< and >v-Maximum< sets the limit values for the velocity measurement. The transmitter ignores single higher and lower velocities which hence will not be indicated. Permanently measured deviations will be represented as "0" and the unit shows only the next following realistic measurement values.

Adjustable values are from -1 to +8 m/s.

Default setting:

- v-Minimum: -1 m/s
- v-Maximum: 6 m/s

A typical application is to avoid the evaluation of negative flow velocities (backflow). In this case simply set the maximum value for negative flow velocities to "0".



Specifications show upper limits

It is not possible to increase the possible flow velocity evaluation to values higher than the technical limits as described in chapter "18 Specifications". The system will not accept such entries.



Fig. 36-22 Limitation of velocity evaluation

36.4 Menu Inputs/Outputs (analog and digital)

This menu is to define the function of the analog as well as digital inputs and outputs. Other parameters such as measurement and output spans, offsets, limit values, error reactions etc. can be set here as well.

➡ Open the >Inputs/Outputs< Menu from >Main Menu</>Application<.

The inputs/outputs menu is subdivided into four parts:

- Analog inputs
- Analog outputs
- Digital inputs
- Digital outputs

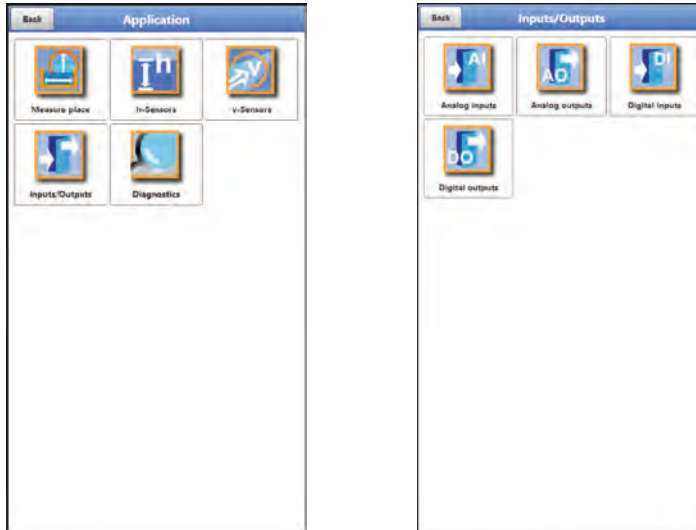

Fig. 36-23 Inputs/Outputs Menu

36.4.1 Analog Inputs

The transmitter is equipped with three analog inputs. The inputs are indicated in the top right display corner from where they can be selected individually. The selected analog input is highlighted and the clear name is indicated in the headline.

Default setting: Input not active

Alternatively, the transmitter can be used as an extra data logger for measurement values from external systems or for supply of analog sensors. This, however, does not influence the instrument's capabilities as flow meter.



Analog input 1 is not always available as data logger

If, when selecting the h-sensors in chap. "36.2 Setting Parameters in Menu h-Sensors", a 2-wire level sensor or an i-Series sensor has been selected, analog input 1 is not available for use as external data logger.



Fig. 36-24 Analog input as external reading

The values below must be chosen/entered in **>External Reading<**.

- Selection/Input Options:
Input Range: >0-20 mA< or >4-20 mA<
Unit: manual input

Linearisation: >2-Point< or >Table<

For >2-Point< linearisation: manual input of values for 4 or 20 mA.

For >Table< linearisation: manual input of the number of >Entries<, then select >Table<, complete and confirm.

36.4.2 Analog Outputs

The transmitter is equipped with one analog output 0-10 V.

Default setting: output not active

The following different functions can be assigned to the analog output:

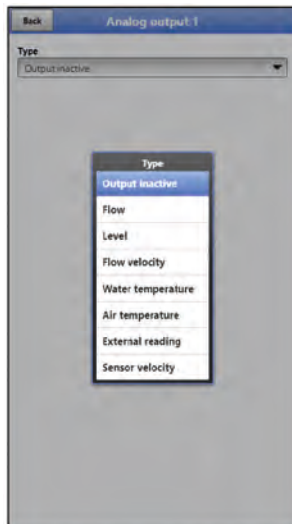

Fig. 36-25 Analog output activation

- **Flow**
The application flow rate (calculated from average flow velocity and wetted cross section) is available on the selected analog output.
 - Selection/Input Options:
Output range: >0-5 V< or >0-10 V<
Value at 0 V: manual input
Value at 10 V: manual input
Value at error: >0 V< or >Hold value< or >10 V<
- **Level**
The level of the current level area is available at the selected analog output.
 - Selection/Input Options:
Output range: >0-5 V< or >0-10 V<
Value at 0 V: manual input
Value at 10 V: manual input
Value at error: >0 V< or >Hold value< or >10 V<
- **Flow Velocity**
The calculated average flow velocity used to compute the current flow rate is available on the selected analog output.
 - Selection/Input Options:
Output range: >0-5 V< or >0-10 V<
Value at 0 V: manual input
Value at 10 V: manual input
Value at error: >0 V< or >Hold value< or >10 V<
- **Water Temperature**
The medium temperature calculated based on the transit times is available on the selected analog output.

- Selection/Input Options:
Output range: >0-5 V< or >0-10 V<
Value at 0 V: manual input
Value at 10 V: manual input
Value at error: >0 V< or >Hold value< or >10 V<
- **Air Temperature**
The air temperature is available on the selected analog output.
 - Selection/Input Options:
Output range: >0-5 V< or >0-10 V<
Value at 0 V: manual input
Value at 10 V: manual input
Value at error: >0 V< or >Hold value< or >10 V<
- **External Reading**
Possibly linearised measurement values available at the analog input are available here.
 - Selection/Input Options:
Analog input: >Input 1< or >Input 2< or >Input 3<
Output range: >0-5 V< or >0-10 V<
Value at 10 V: manual input
Value at error: >0 V< or >Hold value< or >10 V<
- **Sensor Velocity**
In the event of using multiple flow velocity sensors and if the average flow velocity of the individual measurement paths is to be determined, the desired flow velocity sensor can be selected here in order to output its readings at the analog output.
 - Selection/Input Options:
Sensor: >Sensor 1< or >Sensor 2<, depending on the number of connected sensors
Output range: >0-5 V< or >0-10 V<
Value at 0 V: manual input
Value at 10 V: manual input
Value at error: >0 V< or >Hold value< or >10 V<

36.4.3 Digital Inputs

The transmitter is equipped with one digital input.

Default setting: Input not active

The following different functions can be assigned to the digital input.



Fig. 36-26 Digital input activation

- **Run Times**
The system detects and saves the duration of the ongoing signal at the digital input. Such records are used to gather information e.g. on pump run times or other equipment run times.
 - Selection/Input Options:
Logic: >not inverted< or >inverted<
- **Impulse Counter**
The system counts and saves the number of ongoing signals at the digital input. The counter simply counts the status changes detected at the digital input (1->0 or 0->1).
 - Selection/Input Options:
Edge:
>rising< (status change from “0” to “1”) or
>falling< (status change from “1” to “0”)
- **Logging**
Logging of readings and the according status changes for diagnostic purposes. Evaluation is carried out by detecting the status changes of the digital input (1->0 or 0->1).
 - Selection/Input Options:
Logic: >not inverted< or >inverted<

36.4.4 Digital Outputs

The transmitter is equipped with one digital output.

Default setting: output not active

The following different functions can be assigned to the digital output.

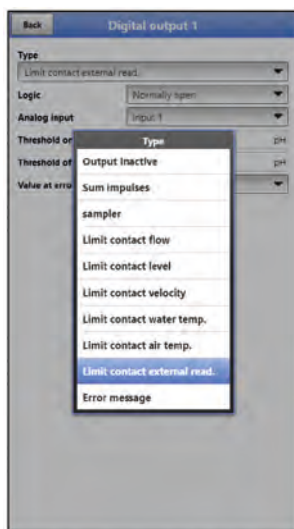

Fig. 36-27 Digital output activation

- **Sum Impulses**
Output of flow-proportional sum impulses.
 - Selection/Input Options:
Logic: >Normally open< or >Normally closed<
Negative sum impulses: check box
Quantity: manual input
Duration: manual input
- **Sampler**
In connection with a sampler provided by the customer it is possible to define the according cyclic control.

- Selection/Input Options:
Logic: >Normally open< or >Normally closed<
Level: manual input; required minimum level for sampling
Volume: manual input; flow volume between two sampling actions
Duration: manual input; impulse duration to harmonise with the sampler
- **Limit Contact Flow**
Exceeding the >Threshold on< value will output a digital signal, falling below >Threshold off< will reset the digital signal = hysteresis function to avoid output flutter.
 - Selection/Input Options:
Logic: >Normally open< or >Normally closed<
Threshold on: manual input
Threshold off: manual input
Value at error: >Off< or >On< or >Hold Value<
- **Limit Contact Level**
Exceeding the >Threshold on< value will output a digital signal, falling below >Threshold off< will reset the digital signal = hysteresis function to avoid output flutter.
 - Selection/Input Options:
Logic: >Normally open< or >Normally closed<
Threshold on: manual input
Threshold off: manual input
Value at error: >Off< or >On< or >Hold Value<
- **Limit Contact Velocity**
Exceeding the >Threshold on< value will output a digital signal, falling below >Threshold off< will reset the digital signal = hysteresis function to avoid output flutter. The calculated average flow velocity (calculated even from multiple paths) is used.
 - Selection/Input Options:
Logic: >Normally open< or >Normally closed<
Threshold on: manual input
Threshold off: manual input
Value at error: >Off< or >On< or >Hold Value<
- **Limit Contact Water Temperature**
Exceeding the >Threshold on< value will output a digital signal, falling below >Threshold off< will reset the digital signal = hysteresis function to avoid output flutter.
 - Selection/Input Options:
Logic: >Normally open< or >Normally closed<
Threshold on: manual input
Threshold off: manual input
Value at error: >Off< or >On< or >Hold Value<
- **Limit Contact Air Temperature**
Exceeding the >Threshold on< value will output a digital signal, falling below >Threshold off< will reset the digital signal = hysteresis function to avoid output flutter.
 - Selection/Input Options:
Logic: >Normally open< or >Normally closed<
Threshold on: manual input
Threshold off: manual input
Value at error: >Off< or >On< or >Hold Value<
- **Limit Contact External Reading**
Exceeding the >Threshold on< value will output a digital signal, falling below >Threshold off< will reset the digital signal = hysteresis function to avoid output flutter.
 - Selection/Input Options:
Logic: >Normally open< or >Normally closed<
Analog input: >Input 1< or >Input 2< or >Input 3<
Threshold on: manual input
Threshold off: manual input
Value at error: >Off< or >On< or >Hold Value<

- **Error Message**

By activating individual selection fields (check box) it is possible to assign individual error types to the digital output. Moreover the output logic can be switched between normally open and normally closed.

- Selection/Input Options:
Logic: >Normally open< or >Normally closed<
v-Measurement: Check box
h-Measurement: Check box
T-Measurement: Check box
External value: Check box
System: Check box

36.5 Diagnostics Menu

The Diagnostics menu is described separately in greater detail in chapter “Diagnostics” starting at page 126 of the instruction manual.

37 Parameter Menu Data

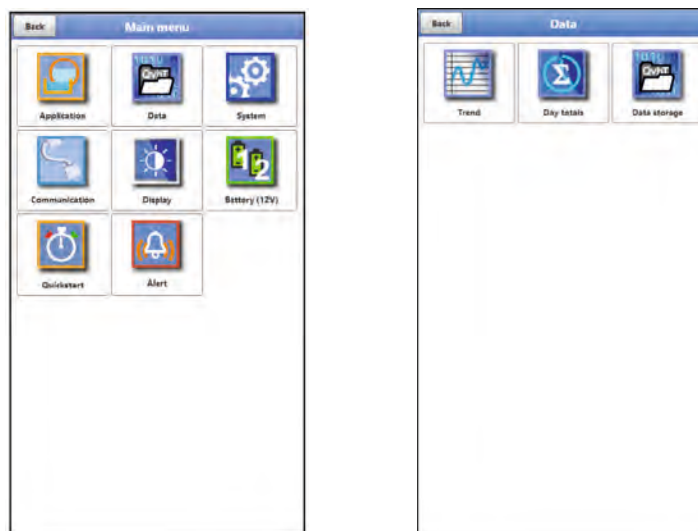

Fig. 37-1 Data Menu

37.1 Trend

The Trend graph is a representational recorder function. Choosing the trend graph provides access to current and previously saved (historic) measurement data.

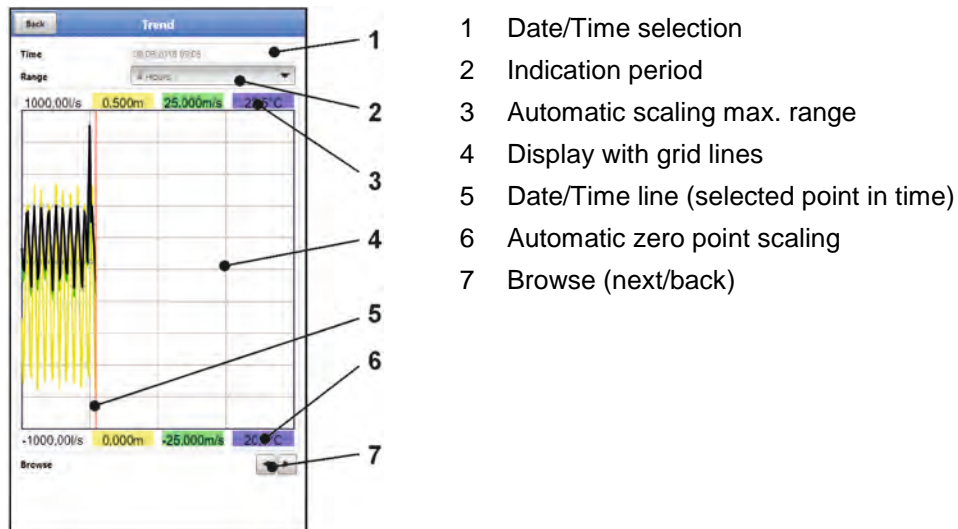

Fig. 37-2 Trend Graph Details

Current Measurement Data

➡ Procedure to view current measurement data:

1. Select the desired range (indication period; Fig. 37-2 no. 2).
The selected range will be indicated. The measurement data will not be automatically updated during indication.
2. Use the arrows (Fig. 37-2 no. 7) to browse next or back if required leaving the basic display settings unaltered.
3. Use "Back" to go back to the main screen.

>Selecting Time/Date<

Opening the Trend menu shows the current date and time. If you wish to view historic readings/a particular point in time select the desired period from the Date/time selection screen (Fig. 37-2 no. 1). Here the selection mask below opens up (Fig. 37-3). The readings are indicated (depending on the period set) in the subsequent screen once a start date is selected.

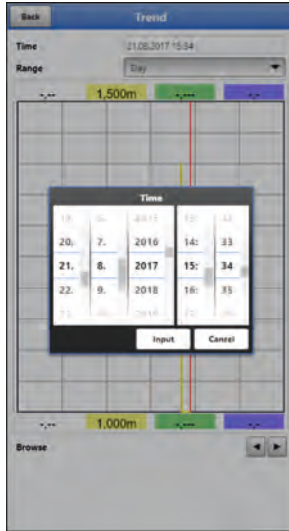

Fig. 37-3 Selecting Time/Date

> Range (Indication Period)<

The range selection determines the period to indicate on the screen.

Selection	Representation on the display		
	Left Margin	Right Margin	Grid Lines
Hour	0 minutes	59 minutes	15 minutes each
4 Hours	0/4/8/12/16/20 o'clock, depending on the time set	4 hours later	1 hour each
Day	0 o'clock	24 o'clock	4 hours each
Week	Monday, 0 o'clock	Sunday, 24 o'clock	1 day each
4 Weeks	Monday, 0 o'clock	4 weeks later, Sunday, 24 o'clock	1 week each; start reference time: 29.12.1969, 0 o'clock

Table 6 Remarks to the periods displayed

37.2 Day Totals

The table below shows the flow rate totals taken in the last 24 hours.

Day totals		
Update (Time) 00:00		
Current 0.000 m³		
Date	Total	
1 30.10.2018 00:00:00	0.000	m³
2 29.10.2018 00:00:00	0.000	m³
3 28.10.2018 00:00:00	0.000	m³
4 27.10.2018 00:00:00	0.000	m³
5 26.10.2018 00:00:00	0.000	m³
6 25.10.2018 00:00:00	0.000	m³
7 24.10.2018 00:00:00	0.000	m³
8 23.10.2018 00:00:00	0.000	m³
9 22.10.2018 00:00:00	0.000	m³
10 21.10.2018 00:00:00	0.000	m³
11 20.10.2018 00:00:00	0.000	m³
12 19.10.2018 00:00:00	0.000	m³
13 18.10.2018 00:00:00	0.000	m³
14 17.10.2018 00:00:00	0.000	m³
15 16.10.2018 00:00:00	0.000	m³
16 15.10.2018 00:00:00	0.000	m³
17 14.10.2018 00:00:00	0.000	m³
18 13.10.2018 00:00:00	0.000	m³
19 12.10.2018 00:00:00	0.000	m³
20 11.10.2018 00:00:00	0.000	m³
21 10.10.2018 00:00:00	0.000	m³
22 09.10.2018 00:00:00	0.000	m³
23 08.10.2018 00:00:00	0.000	m³

Fig. 37-4 Selection Day Totals

Up to 100 totals (= 100 days) are saved. Starting with the 101st value the oldest value will be overwritten (ring memory).

A **prerequisite** to indicate older values is that the instrument has been running for a longer period.

Example: 98 values – the unit has completed 98 totalising processes, so it must be running for at least 98 days.

In general, only day totals can be viewed which have been created while the instrument was actually in operation.

As soon as the NivuFlow Mobile is shut down between two totalising events (<24 hours) the transmitter creates a total using **measured** values. Such totals are **not equal to the actual day total** but reflect the total measured by the transmitter while being in operation.

As soon as the transmitter is shut down before the next totalising event and remains to be off until the next totalising (>24 hours) no totals will be created for this period (Fig. 37-5 no. 2). No data will be stored and no name will be created for this period. This “gap” can be identified from the completely missing entry (date/values) within the listed sequence. **No empty lines** will be created.

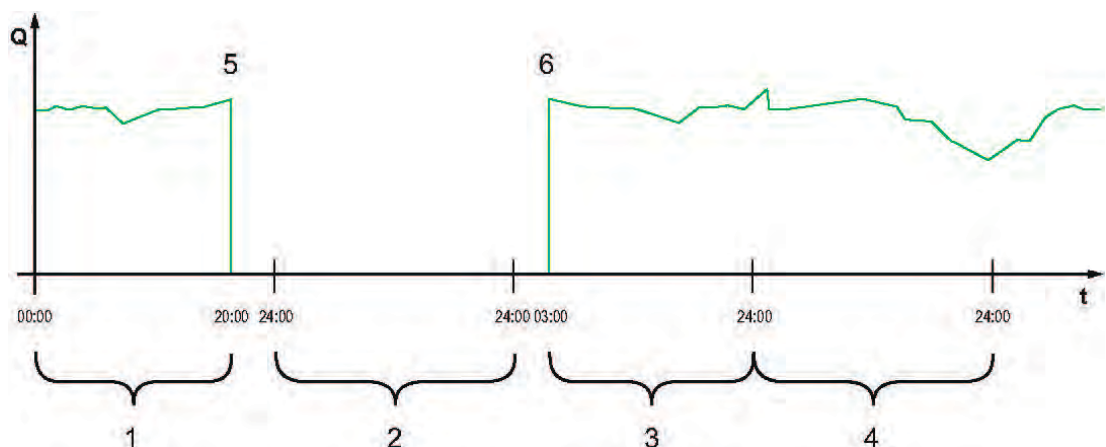

- 1 Total Day 1: Total covering 20 hours
- 2 Day 2: Power failure – no totalising
- 3 Total Day 3: Total covering 21 hours

- 4 Total Day 4: Total covering 24 hours
- 5 Power failure
- 6 Power available again

Fig. 37-5 Totalising scheme

- Per **default** the **totalising period** is between 00:00 o'clock and 24:00 o'clock. This means that day totals are always created between 00:00 o'clock and 24:00 o'clock.
- The **default totalising time** is at 00:00 o'clock.

The totalising time can be modified using >Update (Time)< (Fig. 37-6). Once modified, the totalising will start at the time set and stops 24 hours later.



Fig. 37-6 Updating the totalising time

The value shown in >Current< is the subtotal since the last totalising.

37.3 Data Memory

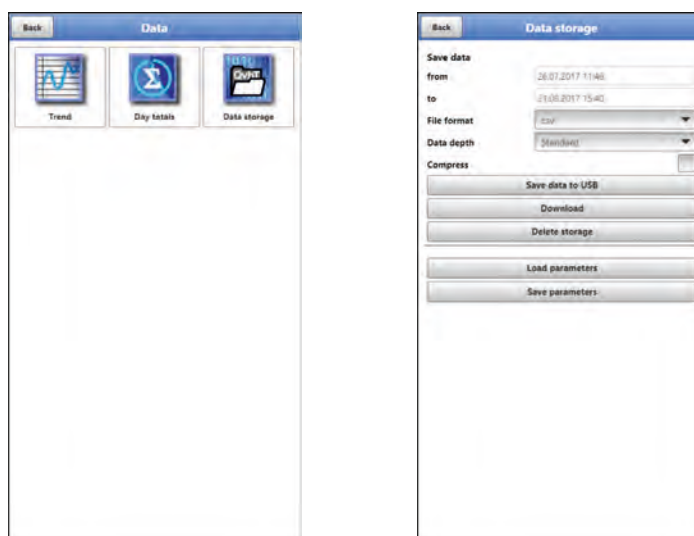

Fig. 37-7 Data Memory Menu

The NivuFlow has an internal data memory (max. 182.398 measurement cycles, more cycles will start overwriting). It is possible to transfer either portions of your data or all saved readings to an USB stick.



Using the USB interface is allowed only outside of Ex areas.

USB Stick Requirements

- Supports USB 2.0
- FAT 32 (or FAT 12 or FAT 16) formatted
- Max. permissible capacity 32 GB



Fig. 37-8 Specify Start/End time

- **>from< / >to<**
This section allows you to determine the desired transmission period. Define the period in some kind of calendar (Fig. 37-8).
Per default the transmitter is set as to transmit the data containing the period between the latest previous transmission and the current time.
- **>File Format<**
>csv< or >txt<
- **>Data Depth<**
Data depth is subdivided into four sections:
 - **>Standard<**
This is the appropriate format for the most applications and hence is the factory default setting.
The saved data sets contain the following information:
 - Date and time
 - Totaliser
 - Calculated flow rate
 - Level
 - Average flow velocity
 - Water temperature
 - Current values as well as the accordingly calculated values of enabled analog and digital inputs
 - Battery voltage
 - NFM power consumption
 - **>Extended<**
This option is appropriate for the verification of critical, important applications and is required mainly for servicing personnel.

The saved data sets contain the following information:

- All data sets from the previous data depth >Standard<
- Average flow velocities of v-sensor(s) 1, 2 and 3 (if used)
- Parameter values for the NIVUS-specific velocity evaluation method >COSP<
- Trigger and hydraulic qualities of v-sensor(s) 1, 2 and 3 (if used).

- **>Expert<**

This option should be used only by trained service personnel or the NIVUS GmbH developers. Such data sets may become very large very quickly. Apart from the data contained with the "Extended" data set, this option includes extra information on all individual gate velocities as well as all gate positions of any connected v-sensors.
If required contact NIVUS.

- **>Day Totals<**

This option saves only the day totals, no individual values.

- **>Compress<**

This function is useful to transmit large data sets. In this case the selected files are zipped as ".zip" files.

- **>Save Data to USB<**

This function permits to save measurement data covering a previously determined period to USB stick.

- **>Download<**

Use this function to save measurement data covering a previously determined period to the operating unit (smartphone, tablet, notebook etc.).

- **>Delete Storage<**

This function can be used to completely erase the internal data memory. Selecting this option will prompt you to confirm. After confirmation with >Yes< the data will be erased, >No< will abort the process.

- **>Load Parameters<**

Use this function to load a parameter file previously saved to USB stick or the operating module back to the transmitter again.

- **>Save Parameters<**

The measurement place parameter sets can be saved to USB stick here. Only two files with the formats below will be created and saved:

- **XXXX_DOC_AABBCCDDEE.pdf**

This file is for documentation purposes and contains basic settings as well as parameter changes.

- **XXXX_PAR_AABBCCDDEE.xml**

This file contains the entire transmitter parameter settings and is used as backup of the current parameter settings.

Remarks on file names:

XXXX = Name of the measurement place set

AA = Year

BB = Month

CC = Day

DD = Hour

EE = Minute

38 System Parameter Menu

38.1 Information

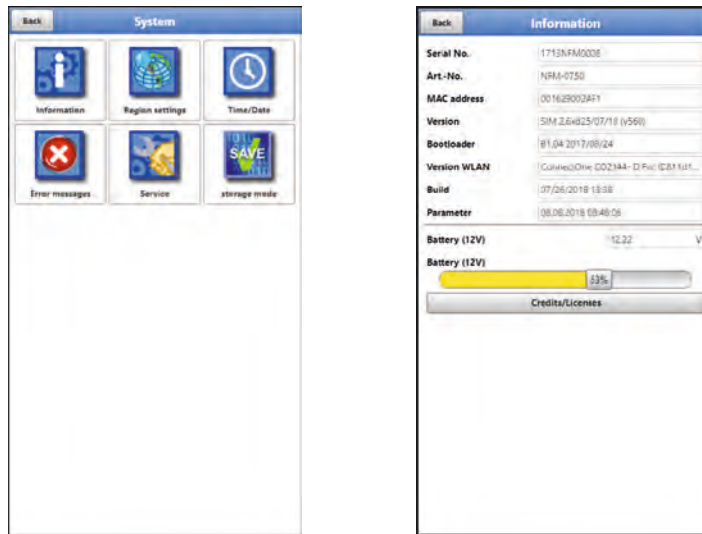

Fig. 38-1 System Information Menu

>Information< is a read-only menu and provides the instrument information below:

- Serial no. and article no.
- MAC address
- Firmware version of the transmitter
- Data on boot loader and WLAN version
- Date of the latest software update (firmware) and the last storage of the parameter sets
- Current battery charging status (when using two batteries the battery with the higher capacity is used until the capacity of both batteries has reached the same level; after that both batteries are discharged equally)
- Information on credits and licenses

38.2 Region Settings

The following settings can be configured here:

- (Operation) Language
- Date format
- Units for measurement values
Here it is possible to distinct between stored and displayed measurement values.

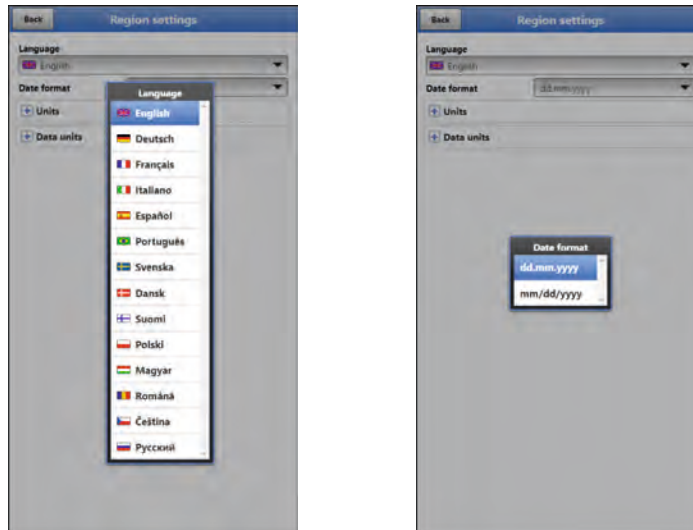

Fig. 38-2 Region Settings - Language – Date Format

38.2.1 (Operation) Language

All listed languages (Fig. 38-2) either contain wordings in the according language or alternatively in English.

38.2.2 Date Format

The date formats below can be set:

- DD.MM.YYYY (Day/Month/Year)
- MM/DD/YYYY (Month/Day/Year)

38.2.3 Units

This menu can be used to adjust various country-specific and unit-specific settings for the indication of measurement values.

>Decimal Separators<

- Comma or Point

The decimal separators specified here are used only for representation on the operation module display.

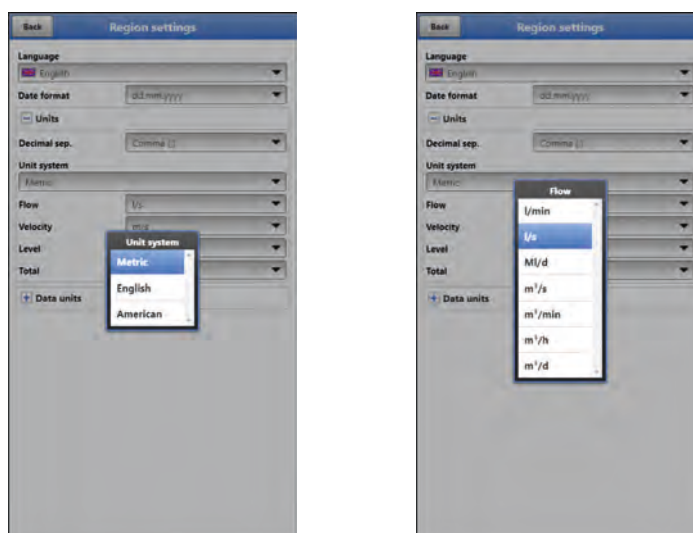

Fig. 38-3 Unit System

>Unit System<

Select from:

- Metric
- English
- American

The **adjustable units** depend on the previously chosen unit system:

- Metric system: l, m³, cm/s etc.
- English system: ft, in, gal/s etc.
- American system: fps, mgd etc.

Units for Display Representation

- Flow
- Flow Velocity
- Level
- Total
- Temperature (for units system “English” only)

38.2.4 Units Memory

The >Units Memory< settings are in line with the >Units< settings.

In >Units Memory< the measurement values are **converted and saved** according to the selected units.

>Decimal Separators<

- Comma
- Point

Specifying the decimal separators is relevant for correct data import. Particularly in case of using foreign software applications (such as foreign Excel) to evaluate readings observe to specify the correct decimal separators.

Units for storage

- Metric system: l/s, m³/s, m³/d, cm/s etc.
- English system: ft³/s, in, gal/min, Mgal/d, in/s, yd/s etc.
- American system: gps, gpm, cfs, cfm, cfh, cfd, mgd etc.

Units for the storage of measurement values

- Flow
- Flow Velocity
- Level
- Total
- Temperature (for units system “English” only)

38.3 Time/Date

This submenu allows you to modify the current date and the transmitter system time. The system time is based on the coordinated universal time UTC (French: “Temps universel coordonné”) with “Plus-” or “Minus-Hours” symbols defining the time zones compared to UTC.

NIVUS highly recommend to leave the transmitter system time unchanged and to define your time zone as well as summer and winter times by using the >Time Zone (UTC)< function.

Use >**Sync Time/Date**< to synchronise date and system time automatically with the display and operation module.

Modifications in the >Time/Date< menu may be necessary to switch from summer time to winter time, due to internal buffer battery failure or after power failure.

The internal clock may deviate when the transmitter has been operated for a long time. Such deviations can be corrected here.



Effects of changing the system time

Changing the system time has an effect on the storage of data. If the data storage option is enabled, duplicate data or data gaps may occur after the system time has been modified.



Fig. 38-4 Change System Time: manually and automatically

The current system time can be set in the menu above (Fig. 38-4).

Set the time difference (UTC or GMT) to the prime meridian with “+” and “-”:

- = decrease by 1 hour each
- = decrease by ½ hour each
- + = increase by ½ hour each
- ++ = increase by 1 hour each

38.4 Error Messages

Use this menu to recall the currently active queued error messages and to erase the error message memory.

The content of the error memory will be instantly erased by choosing >Erase Error Memory<, no security prompt will come up.

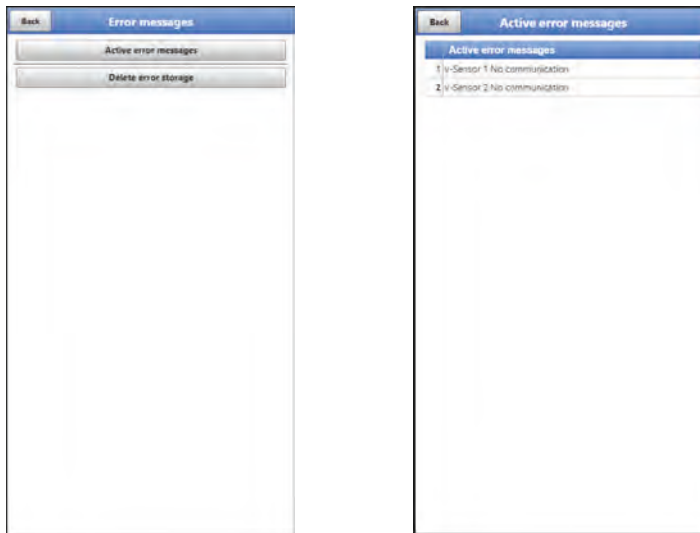

Fig. 38-5 Error Messages

38.5 Service

This submenu contains the following functions:

- Service levels (password-protected); the service levels are reserved exclusively for NIVUS service personnel
- Restart (of system)
- Powerdown (transmitter goes to energy saving mode)
- Parameter reset (back to default settings)
- Update NivuFlow
- Update Bootloader

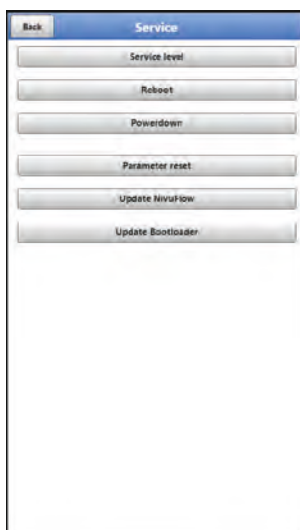

Fig. 38-6 Service

38.5.1 Service Level

The service levels are split into different, accordingly password-protected access levels. The possible settings as well as the information available here require comprehensive expert knowledge and are not needed for standard applications. This is why the service level is reserved for NIVUS service personnel exclusively.

38.5.2 Restart

A transmitter restart interrupts the current measuring process. The system will boot using the parameters previously set (saved). After the boot process the system behaves as if being switched on (analog to a PC). This menu point saves you from shutting down and restarting the system. All saved parameters, counters and data will be preserved.

38.5.3 Powerdown

The >Powerdown< function switches the transmitter to energy saving mode. The instrument will not resume measuring before it has been “woken up”.

38.5.4 Parameter Reset

A parameter reset will reset all parameters to factory default settings. Counter readings, modified passwords and saved measurement data are preserved. The parameters will not be actually reset before you exit the service menu (back to main menu) and confirm the storage process. At this point you can still abort the reset.

38.5.5 Update NivuFlow

Upload of a NivuFlow Mobile firmware saved on USB.

38.5.6 Update Bootloader

Upload of a bootloader software saved on USB.

38.6 Storage Mode

The >Storage Mode< menu determines the >Operating Mode< and the >Storage Cycle<.

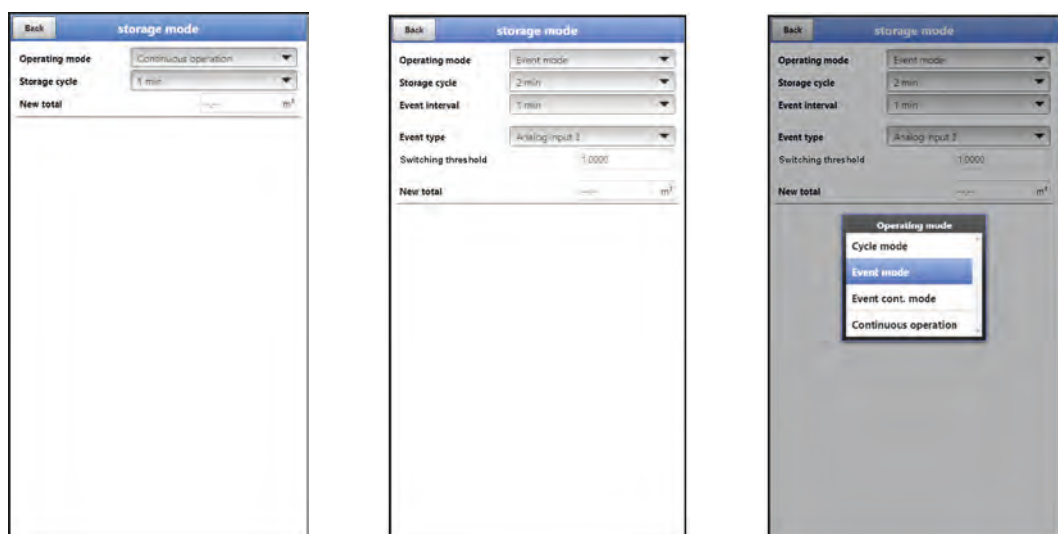

Fig. 38-7 Storage Mode – Operating Mode

Operating Mode, Storage Cycle, Event Interval and Event type

The operation mode determines when and how often the transmitter shall measure and when and how often the measurements shall be saved. Storage cycle, event interval and event type can be adjusted depending on the operation mode.

To choose the **>Operation Mode<** select from

- **>Cycle Mode<**
The transmitter wakes up at the intervals set in storage cycle, executes a brief measurement and saves the data. After that the transmitter goes back to “sleep mode” until the next measurement.
- **>Event Mode<**
On one hand, the transmitter behaves like being in cyclic operation, however it is possible to additionally set an event interval. The transmitter then wakes up at previously defined events, measures and saves data at the adjusted event intervals.
- **>Continuous Event Mode<**
In this mode the transmitter basically operates like being event operation, however measures continuously during the event. The instrument saves the data at the adjusted event intervals.
- **>Continuous Operation<**
The transmitter measures continuously, however will save the data only at the intervals set with the storage cycle.

>Storage Cycle<

Select from (depending on the operation mode set): (5 s, 10 s, 20 s, 30 s,) 1 min, 2 min, 5 min, 10 min, 30 min und 1 h

>Event Interval<

Available settings: 1 min, 2 min and 5 min

>Event type< (only with Event mode and Continuous event mode)

The operation modes “Event mode” and “Continuous event mode” allow to (depending on the parameters) additionally select the event types “Flow”, “Level”, “Velocity”, “Water temperature”, “Air temperature”, “Analog input 1”, “Analog input 2”, “Analog input 3” and “Digital input 1”.

Except for “Digital input 1” the “Switching threshold” for switchover can be defined for each of the parameters.

The indicated selection of event types varies depending on the parameter settings.

>New total<

Here either the flow rate can be reset to “0” or a new (basic) value for the flow rate can be set. This may become necessary after transmitter replacement or as soon as the parameters for a new measurement place need to be adjusted.



Fig. 38-8 Event types

39 Parameter Menu Communication

This menu is used to set up communication with the display and operation module (smartphone, tablet, notebook etc.) or other devices. The transmitter communicates via WLAN and GPRS.

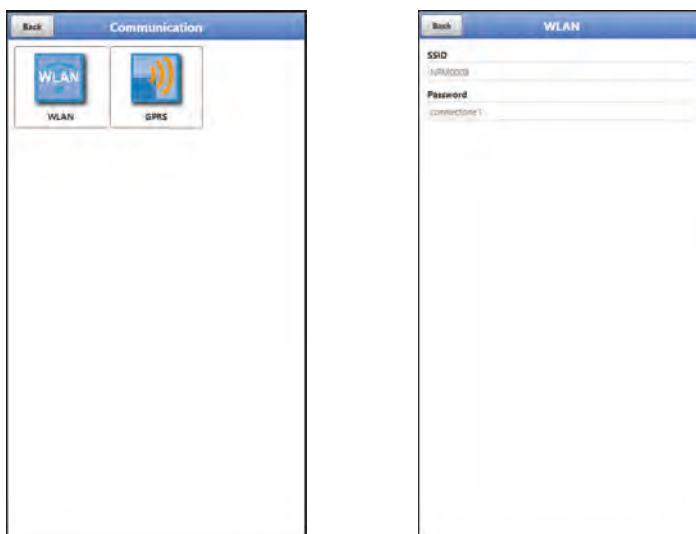

Fig. 39-1 Menu - Communication

The **>WLAN<** menu provides information on SSID and the WLAN password. This is a read-only menu.

➡ To change the WLAN password see chapter “33.2 Change WLAN Password”.

Prepare the device for data transmission

Use the button **>Start data transmission<** to cause the NivuFlow Mobile to transmit data to the NIVUS Web Portal where the data can be selected/shown. To indicate the according measurement place correctly on the overview map in the NIVUS Web Portal featuring the respective GPS coordinates it is necessary to correctly set these specifications once. There is no automatic update during measurement operation.

Precondition

The device shall be positioned so as to have an unobstructed view to the sky, i. e. best before being located within a shaft or a room.

Procedure

1. Start the modem under >Modem state<.
2. Wait until the device has found and entered the correct GPS coordinates (latitude/longitude) in the menu (see Fig. 39-3). This may take up to several minutes.
The measurement place will be not correctly indicated in the NIVUS Web Portal overview map without the GPS coordinates. In any event, data will be assigned to the right measurement place, however.
3. Use the >Start data transmission button to transmit data once and to make sure that the connection has been set up successfully and GPS coordinates are transmitted.
Then the NivuFlow Mobile can be positioned in its planned installation place.

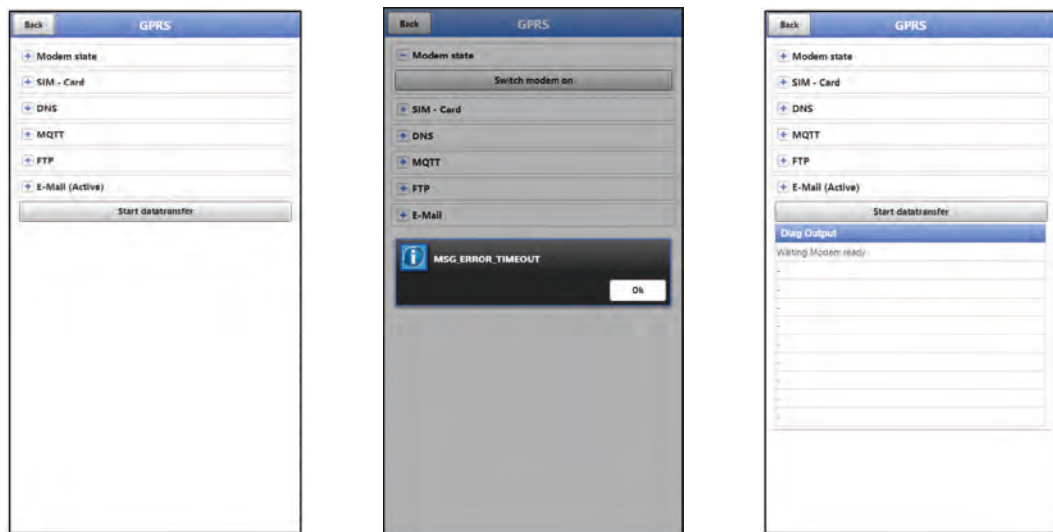

Fig. 39-2 GPRS menu / Modem error message / Diag Output

Set up and adjust the data remote transmission in the >GPRS< menu.

After **inserting the SIM card** the following submenus can be used. Without the SIM card the message "ERROR" or "MSG_ERROR_TIMEOUT" is shown and an according message is indicated in >Diag Output< too.

- **>Modem state<**
 - **>Switch modem on<**: Modem and SIM are initialised and current network status is displayed (signal strength, net, frequency band, operator, latitude, longitude, height over sea level and number of satellites).
 - **>Test connection<**: A test connection can be set up after a successful start. During this procedure >Diag Output< indicates a current status info.

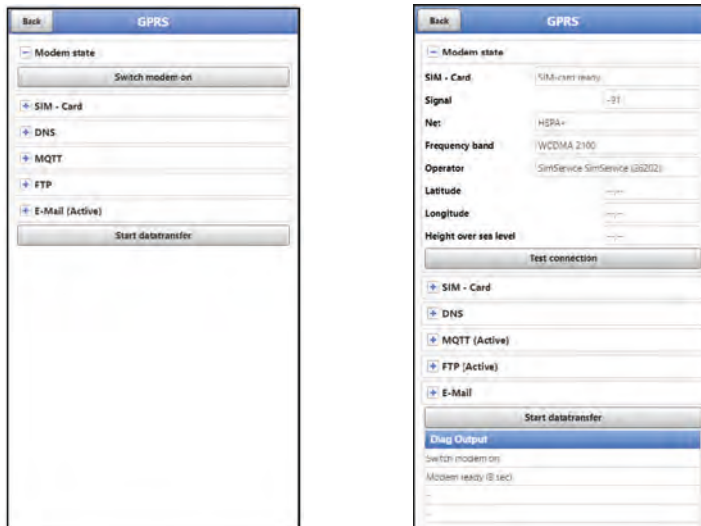

Fig. 39-3 Modem state / SIM-Card state

- **>SIM-Card<**

- **>Get state<**: The PIN verification status is queried and indicated.
 - Enter the according PIN as soon as the PIN check is active.
 - The field may be left empty if the PIN check is not active.
- **>Activate pin check<**:
 - To activate enter the PIN and select >Change Pin<.
 - To change the PIN with the PIN check active enter the new PIN and then select >Change Pin<.
 - If the PIN is entered incorrectly three times, the value must be entered using the PUK (found in the unit lid) and a new PIN needs to be specified.
- **>Provider<**: selection of providers; available are T-Mobile Deutschland, Vodafone, O2, NIVUS and User defined;
 - If user defined is selected enter the provider access data: APN (Access Point Name), possibly user name, possibly password, IP address if required.

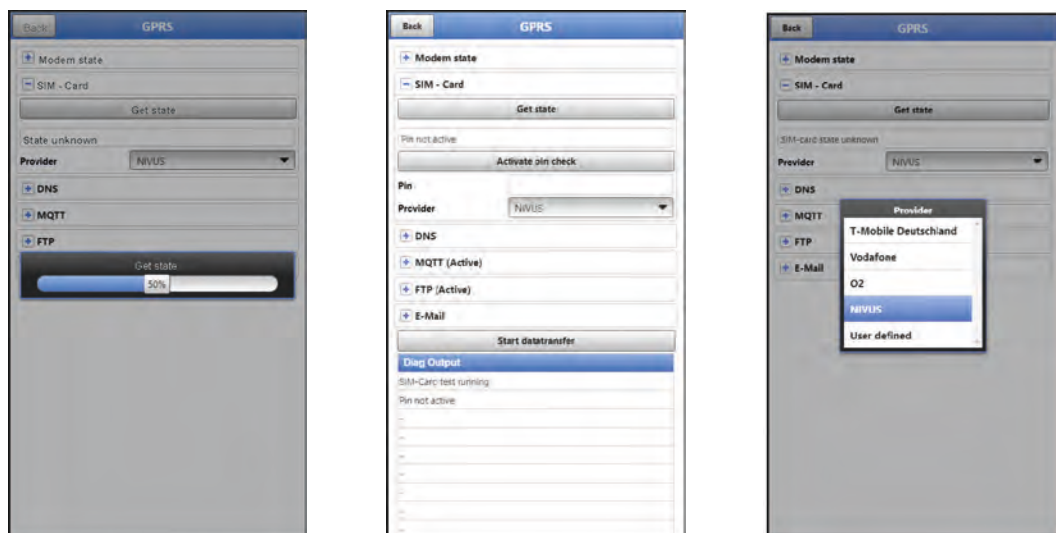

Fig. 39-4 SIM-Card

- **>DNS<**:
 - Names will be normally assigned automatically (default setting); if the provider requires a certain DNS please enter accordingly.

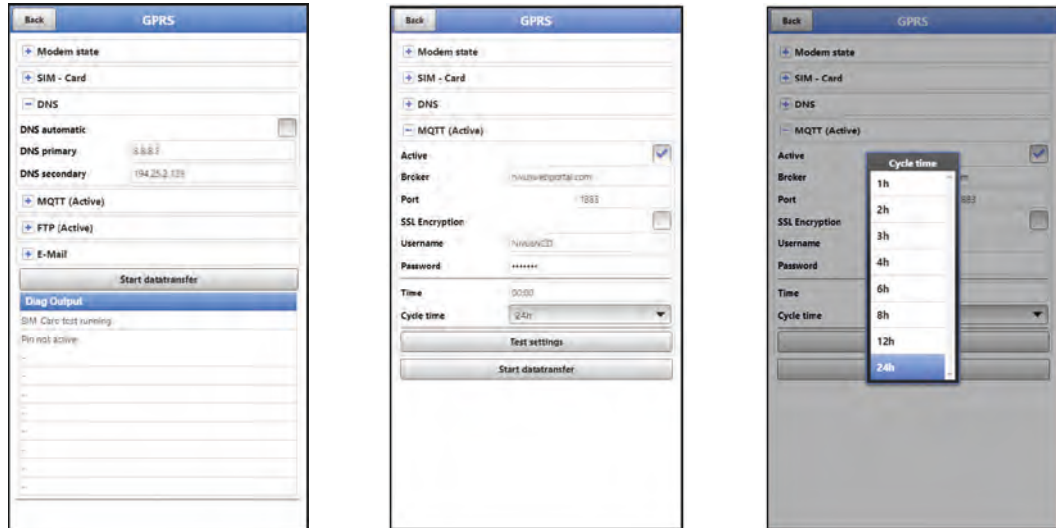

Fig. 39-5 DNS / MQTT

Default setting: Transmission to NIVUS Web portal (MQTT).

Access data can be requested from NIVUS via E-Mail.

If you wish to use a transmission option other than the pre-set option (>FTP< or >E-Mail<), the MQTT transmission must be deactivated first and then the alternative must be activated.

- **>MQTT<**

Transmission to NIVUS web portal; alternatively the MQTT protocol can be used to set up a direct connection to customer systems, in such cases contact the NIVUS customer centre.

- Check the according box if the transmission shall be executed via MQTT. The settings for transmission to the NIVUS Web Portal are preconfigured.
- **>Time<**: Specify the time of daily transmission.
- **>Cycle time<**: Set the transmission cycle in hours (1, 2, 3, 4, 6, 8, 12 or 24h).
- **>Test settings<**: Use this menu to verify the settings, the results can be viewed in >Diag Output<.
- **>Start Data Transmission<**: Data (error information, archived data and current values) is transmitted, the result is issued on >Diag Output<.



Follow the procedure described in “Prepare the device for data transmission” on page 109.

- **>FTP<**

Transmission to customer FTP server or to D2W data portal.

- For transmission to FTP server check the according box.
- **>Server<**: Enter server name or IP.
- **>Port<**: Enter FTP-Port (standard 21).
- SSL encryption can be selected optionally.
- **>Authentication<**: Activate if the FTP access is user and password protected and specify user as well as password.
- **>Destination folder<**: Specify the destination directory where files are to be saved.
- **>Device to Web<**: Activate in case of transmission to D2W; a format compatible to Device to Web will be used.
- **>File format<**: Available formats are csv and txt.

- **>Data<**: Specify the data depth to transmit (Standard, Extended and Expert) (see chapter “37.3 Data Memory”).
- **>Time<**: Specify the time of regular transmissions; the time specified serves as start time for the cyclic transmissions.
- **>Cycle time<**: Set the transmission cycle in hours (1, 2, 3, 4, 6, 8, 12 or 24h).
- **>Test settings<**: Use this menu to verify the settings, the results can be viewed in >Diag Output<.
- **>Start Data Transmission<**: Data (error information, archived data and current values) is transmitted, the result is issued on >Diag Output<.

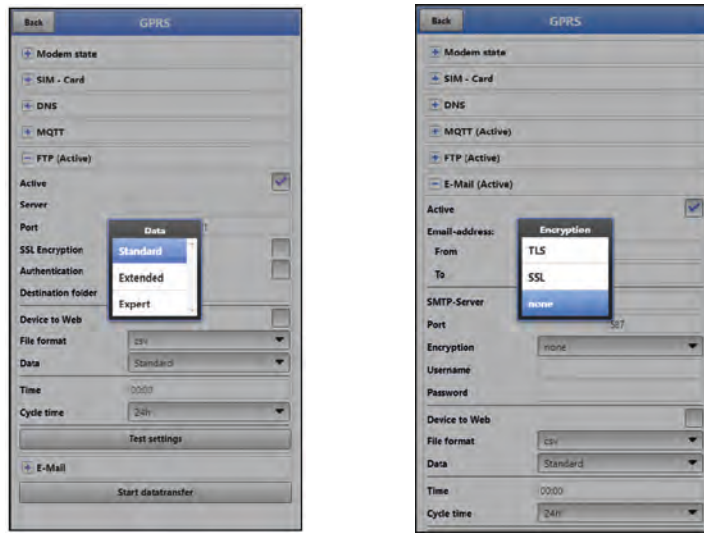

Fig. 39-6 FTP / E-Mail

- **>E-Mail<**
Transmission to e-mail address.
The access data >SMTP server<, >User name< and >Password< are available from your e-mail provider.
 - Check the according box for transmission to an e-mail address.
 - **>Email-address<**:
 - >From<: E-mail sender address (must be accepted by SMTP server)
 - >To<: E-mail destination address
 - **>SMTP-Server<**: Specify e-mail server name (e.g. mail.gmx.net). Provider must support SMTP (Simple Mail Transfer Protocol).
 - **>Port<**: Enter the port of the SMTP outgoing mail server.
 - SSL encryption can be selected optionally.
 - **>Username<**: E-mailbox user name.
 - **>Password<**: Enter the password of the e-mailbox.
 - **>Device to Web<**: Activate in case of transmission to D2W; a format compatible to Device to Web will be used.
 - **>File format<**: Available formats are csv and txt.
 - **>Data<**: Specify the data depth to transmit (Standard, Extended and Expert) (see chapter “37.3 Data Memory”).
 - **>Time<**: Specify the time of regular transmissions; the time specified serves as start time for the cyclic transmissions.
 - **>Cycle time<**: Set the transmission cycle in hours (1, 2, 3, 4, 6, 8, 12 or 24h).

- **>Test settings<**: Use this menu to verify the settings, the results can be viewed in >Diag Output<.
- **>Start Data Transmission<**: Data (error information, archived data and current values) is transmitted, the result is issued on >Diag Output<.

40 Parameter Menu Display

Use the display menu to determine main screen attributes.

Variable settings:

- Names of the five main screen output fields
- Decimal places of individual values

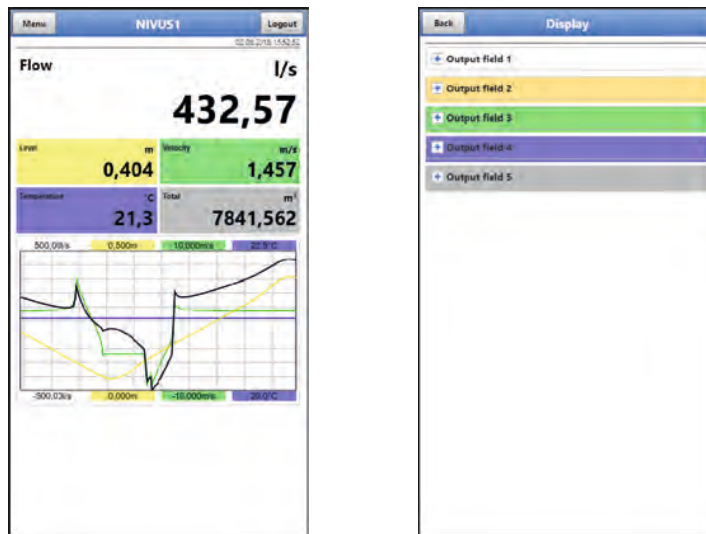

Fig. 40-1 Main screen and output fields

Output Fields

The five main screen output fields (Flow, Level, Velocity, Temperature and Total) can be specified freely in terms of name and the number of decimal places.



Assignment of values and output fields

The **assignment** of values and fields **cannot** be changed.

Example: the "Flow" field will **always** indicate output values even if the name should be changed to "Temperature".



Procedure to change the name:

1. Drop down the desired output field.
2. Uncheck >Standard Name<.
3. Specify the new name. The name can be selected freely, however more than 16 characters will not be accepted.
The new name does **not** change the field value in the main screen.
4. Go "Back" several times to save the parameters



To save see chapter "33.1 Save Parameters".



Procedure to change the number of decimal places:

1. Drop down the desired output field.

2. Uncheck >Default Digits<.
3. Specify the new number of digits.
Here you can enter any desired number, however more than a maximum of five digits will not be accepted.
4. Go “Back” several times to save the parameters.



Setting the number of digits

When setting the number of digits observe the measurement accuracy of the sensors and the measurement units set.

Example: the maximum resolution of the temperature sensor is 0.1 K.

41 Parameter Menu Battery (12V)

Use this menu to define the (rechargeable) battery type used as well as the according number of batteries.



Correct Indication of Battery Capacity

The capacity indication in the >System</>Information< menu is reliable only as long as fully charged batteries are used and the battery type used as well as the according number of batteries are specified here.

Select from:

- **1x NFM0 ZAPB 1215 (E)**
One NIVUS rechargeable battery installed. The battery specifications are known and available from the software.
Setting the number of the NIVUS batteries used enables the correct indication of the battery performance in the >System</>Information< menu.
- **2x NFM0 ZAPB 1215 (E)**
Two NIVUS rechargeable batteries installed.
- **BATTERIE_MODE_USER**
The capacity [Ah] must be specified to correctly indicate the (rechargeable) battery performance in the >System</>Information< menu.

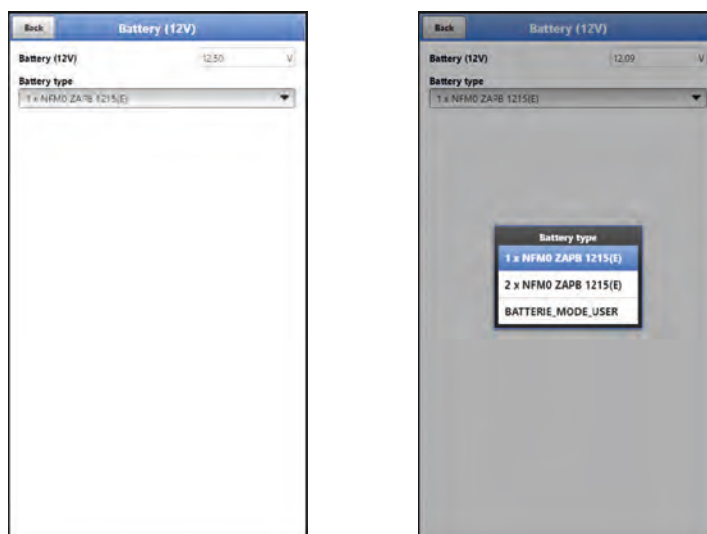

Fig. 41-1 Menu Battery (12V)

42 Parameter Menu Quick Start

The >Quick Start< parameter menu is subdivided into four to six pages (depending on the number of v-sensors). The pages >Region Settings< and >Measure Place< are input pages used to define the indication of measurement values and the measurement place itself. On the pages >h-Sensors<, >v-Sensor 1<, >v-Sensor 2< and >v-Sensor 3< sensors can be selected and the respective parameters can be set.

- ➡ The parameter setting procedure is described in chapter “34 Parameter Setting using Quick Start”.

42.1 Menu >Quick Start< / >Region Settings<



Fig. 42-1 Region Settings

Use >Region Settings< to adjust the parameters below:

- (Operation) Language
- Date Format
- Units and Memory Units
- Change system time and timezone
- Storage Mode
 - Operating Mode
 - Storage Cycle

The settings are explained in greater detail in chapters “38.2 Region Settings”, “38.3 Time/Date” and “38.6 Storage Mode”.

42.2 Menu >Quick Start< / >Measure Place<

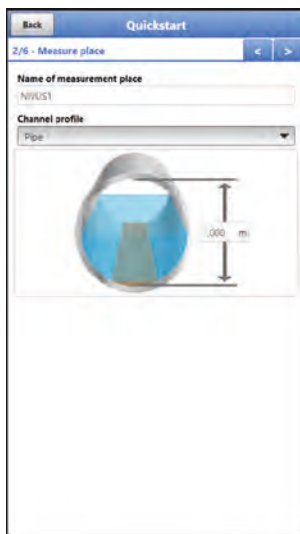

Fig. 42-2 Measurement Place

The following parameters could be set in the >Measure Place< menu:

- Name of Measurement Place
- Channel Profile and Dimensions

The individual settings are explained in greater detail in chapter “36.1 Menu Measure Place”.

42.3 Menu >Quick Start< / >h-Sensors<

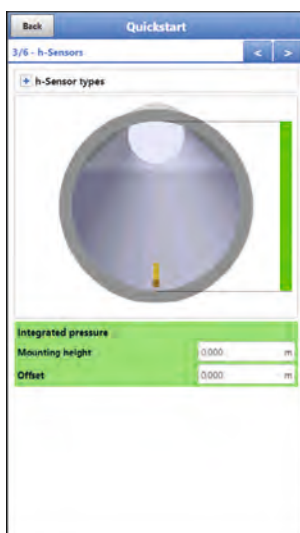

Fig. 42-3 h-Sensors

Selecting the page >h-Sensors< causes the software to check the connected sensors and to set the according values directly as presets. However, these presets can be modified.

Under >h-Sensors< the parameters below are set:

- Selection of h-Sensor types
- Mounting data

The individual settings are explained in greater detail in chapter “36.2 Setting Parameters in Menu h-Sensors”.

42.4 Menu >Quick Start< / >v-Sensor 1<

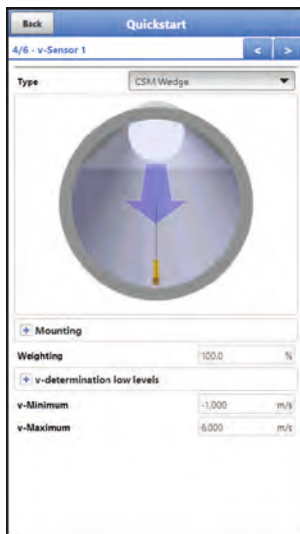

Fig. 42-4 v-Sensor 1

Under >v-Sensor 1< the parameters below are set:

- Selection of v-Sensor types
- Mounting data
- Weighting
- v-determination low levels
- Limitation of velocity evaluation (v-Minimum/v-Maximum)

In case of using multiple sensors use pages “5/6 v-Sensor 2” and “6/6 v-Sensor 3” to set the according parameters.

The individual settings are explained in greater detail in chapter “36.3 Setting Parameters in Menu v-Sensors”.

43 Parameter Menu Alert

The alert menu includes up to nine subsections: >Flow<, >Level<, >Velocity<, >Water Temperature<, >Battery (12V)<, >Analog Input 1<, >Analog Input 2<, >Analog Input 3< and >Digital Input<.

All subsections can be viewed only as soon as the analog and digital inputs have been previously assigned to a type under >Application< and hence have been activated (see chap. “36.4.1 Analog Inputs” and “36.4.3 Digital Inputs”).



Details on alarm management, alarm messages, alarm overview, status information etc. going beyond this instruction manual, can be found also in the NIVUS Web Portal handbook.

43.1 Menu >Alert< / >Flow<

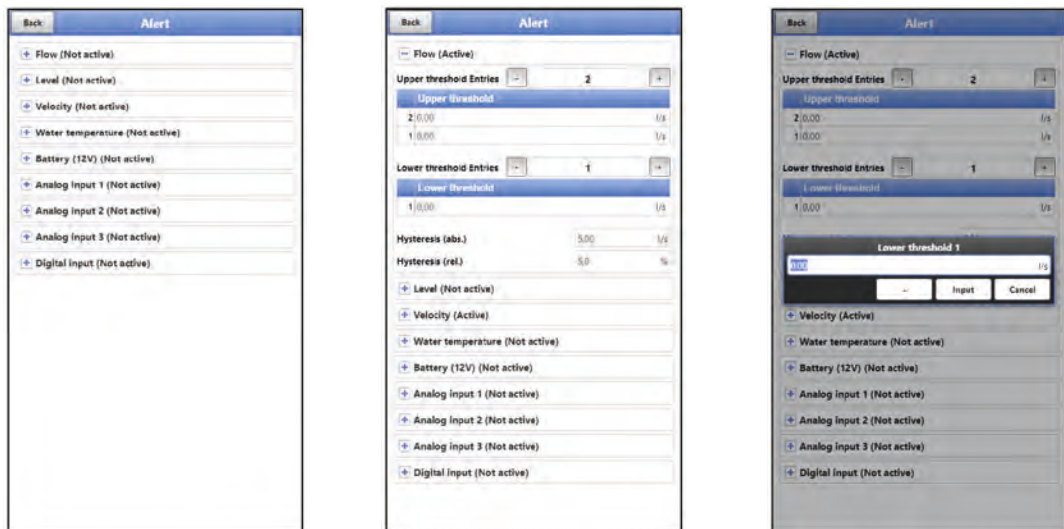

Fig. 43-1 Flow

The >Flow< subsection permits to specify up to five different limit values by using the “+” and “-” keys in >Upper threshold Entries< and in >Lower threshold Entries< each of which is used to trigger an alarm e-mail.

Define the threshold values by clicking the fields and by entering numerical values. The measurement transmitter will sort the specified threshold values in decreasing order. This is made independent from the input sequence.

In >Hysteresis (abs.)< and >Hysteresis (rel.)< values can be specified by clicking and typing. The measurement transmitter evaluates both values and sends an e-mail on reaching the highest top limit (highest possible value) and the lowest bottom value (lowest possible value). This mail includes the information that the alert is cancelled.

Default settings:

Hysteresis (abs.): values and units depend on the language settings previously adjusted

Hysteresis (rel.): 5,0 %



Alarm-E-Mail in case of defective flow velocity sensor

If you wish to receive an alert in case of a defective flow velocity sensor via e-mail check >Alert on error< under “43.1 Menu >Alert< / >Water temperature<”.

This setting is not adjusted in the “Flow” section here since the transmitter does not distinguish between “invalid” and “Error” during detection.

43.2 Menu >Alert< / >Level<

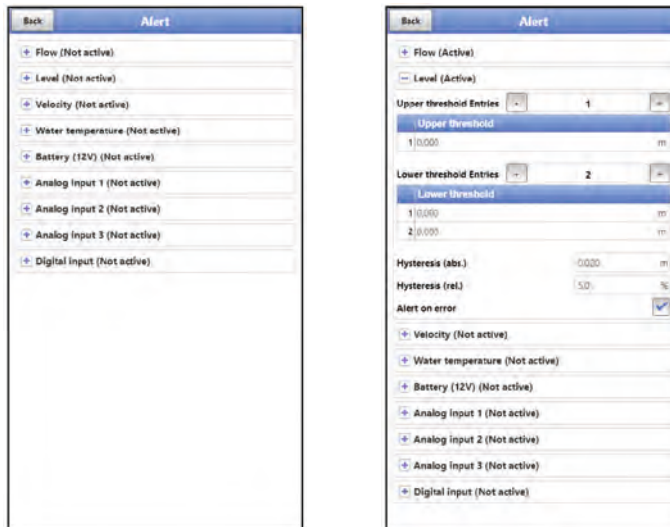

Fig. 43-2 Level

The >Level< subsection permits to specify up to five different limit values by using the “+” and “-” keys in >Upper threshold Entries< and in >Lower threshold Entries< each of which is used to trigger an alarm e-mail.

Define the threshold values by clicking the fields and by entering numerical values. The measurement transmitter will sort the specified threshold values in decreasing order. This is made independent from the input sequence.

In >Hysteresis (abs.)< and >Hysteresis (rel.)< values can be specified by clicking and typing. The measurement transmitter evaluates both values and sends an e-mail on reaching the highest top limit (highest possible value) and the lowest bottom value (lowest possible value). This mail includes the information that the alert is cancelled.

Default settings:

Hysteresis (abs.): values and units depend on the language settings previously adjusted

Hysteresis (rel.): 5,0 %

Moreover, the >Alert on error< option can be checked causing an active ongoing alert to send an alarm e-mail. Possible errors are cable breaks, interruptions, short circuits etc.

43.1 Menu >Alert< / >Velocity<

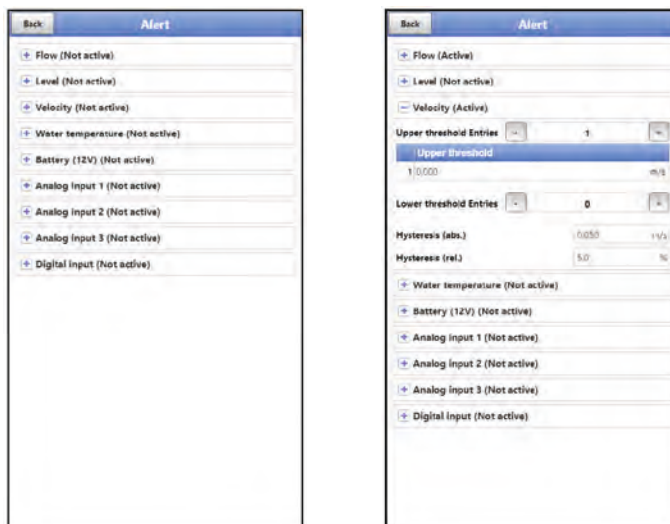

Fig. 43-3 Velocity

The >Velocity< subsection permits to specify up to five different limit values by using the “+” and “-” keys in >Upper threshold Entries< and in >Lower threshold Entries< each of which is used to trigger an alarm e-mail.

Define the threshold values by clicking the fields and by entering numerical values. The measurement transmitter will sort the specified threshold values in decreasing order. This is made independent from the input sequence.

In >Hysteresis (abs.)< and >Hysteresis (rel.)< values can be specified by clicking and typing. The measurement transmitter evaluates both values and sends an e-mail on reaching the highest top limit (highest possible value) and the lowest bottom value (lowest possible value). This mail includes the information that the alert is cancelled.

Default settings:

Hysteresis (abs.): values and units depend on the language settings previously adjusted

Hysteresis (rel.): 5,0 %



Alarm-E-Mail in case of defective flow velocity sensor

If you wish to receive an alert in case of a defective flow velocity sensor via email check >Alert on error< under “43.1 Menu >Alert< / >Water temperature<”.

This setting is not adjusted in the “Velocity” section here since the transmitter does not distinguish between “invalid” and “Error” during detection.

43.1 Menu >Alert< / >Water temperature<

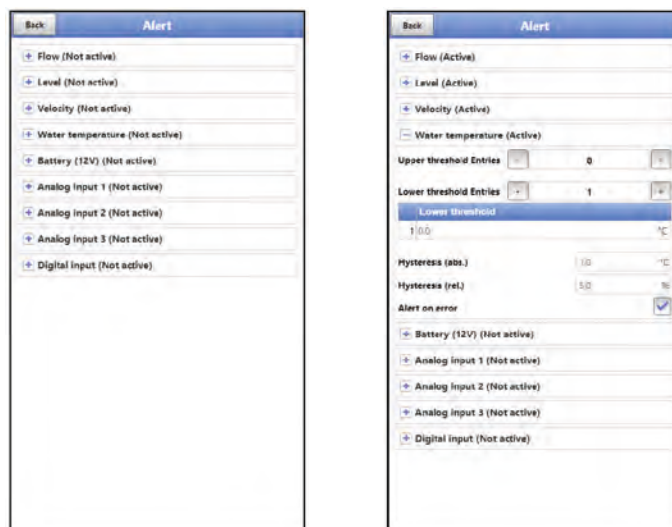

Fig. 43-4 Water temperature

The >Water temperature< subsection permits to specify up to five different limit values by using the “+” and “-” keys in >Upper threshold Entries< and in >Lower threshold Entries< each of which is used to trigger an alarm e-mail.

Define the threshold values by clicking the fields and by entering numerical values. The measurement transmitter will sort the specified threshold values in decreasing order. This is made independent from the input sequence.

In >Hysteresis (abs.)< and >Hysteresis (rel.)< values can be specified by clicking and typing. The measurement transmitter evaluates both values and sends an e-mail on reaching the highest top limit (highest possible value) and the lowest bottom value (lowest possible value). This mail includes the information that the alert is cancelled.

Default settings:

Hysteresis (abs.): values and units depend on the language settings previously adjusted
Hysteresis (rel.): 5,0 %

Moreover, the **>Alert on error<** option can be checked causing an active ongoing alert to send an alarm e-mail. Possible errors are cable breaks, interruptions, short circuits etc.

NIVUS recommend checking this option in order to receive an alert via e-mail once a flow velocity sensor should be defective. A defect on the flow velocity sensor causes the flow measurement to fail.

43.1 Menu >Alert< / >Battery (12V)<

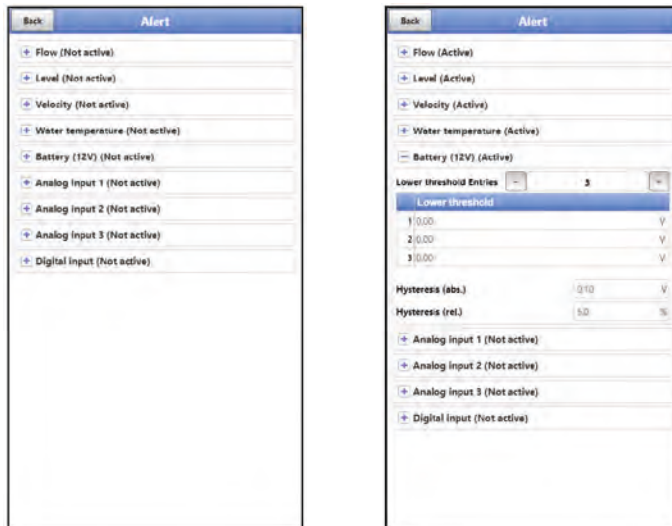

Fig. 43-5 Battery (12V)

The **>Battery (12V)<** subsection permits to specify up to five different limit values by using the „+“ and „-“ keys in **>Lower threshold Entries<** each of which is used to trigger an alarm e-mail.

Define the threshold values by clicking the fields and by entering numerical values. The measurement transmitter will sort the specified threshold values in decreasing order. This is made independent from the input sequence.

In **>Hysteresis (abs.)<** and **>Hysteresis (rel.)<** values can be specified by clicking and typing. The measurement transmitter evaluates both values and sends an e-mail on reaching the highest top limit (highest possible value) and the lowest bottom value (lowest possible value). This mail includes the information that the alert is cancelled.

Default settings:

Hysteresis (abs.): 0,10 V
Hysteresis (rel.): 5,0 %

43.1 Menu >Alert< / >Analog Input 1<

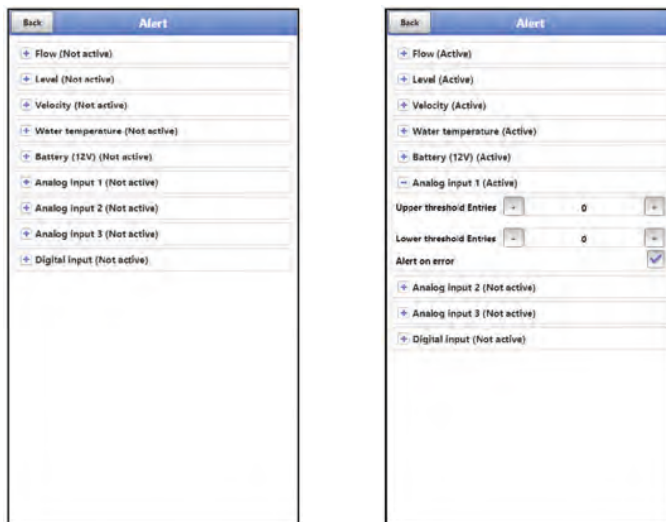

Fig. 43-6 Analog Input 1

The >Analog Input 1< subsection permits to specify up to five different limit values by using the “+” and “-” keys in >Upper threshold Entries< and in >Lower threshold Entries< each of which is used to trigger an alarm e-mail.

Define the threshold values by clicking the fields and by entering numerical values. The measurement transmitter will sort the specified threshold values in decreasing order. This is made independent from the input sequence.

In >Hysteresis (abs.)< and >Hysteresis (rel.)< values can be specified by clicking and typing. The measurement transmitter evaluates both values and sends an e-mail on reaching the highest top limit (highest possible value) and the lowest bottom value (lowest possible value). This mail includes the information that the alert is cancelled.

Default settings:

Hysteresis (abs.): any value can be set, manual input while setting the analog input parameters

Hysteresis (rel.): 5 %

Moreover, the >Alert on error< option can be checked causing an active ongoing alert to send an alarm e-mail. Possible errors are cable breaks, interruptions, short circuits etc.

43.1 Menu >Alert< / >Analog Input 2<

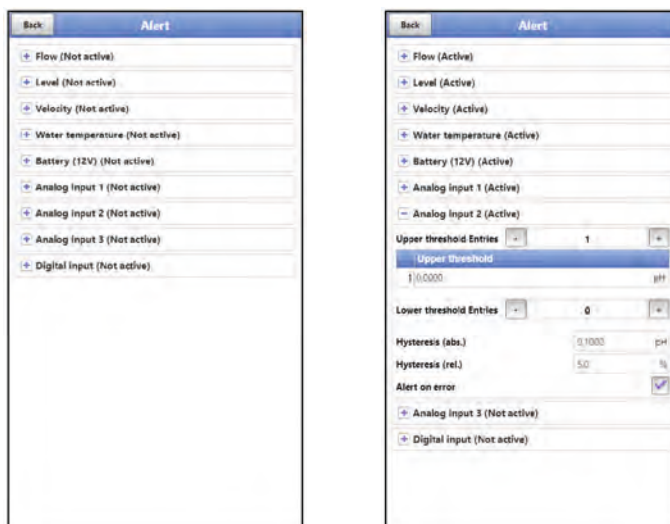

Fig. 43-7 Analog Input 2

The >Analog Input 2< subsection permits to specify up to five different limit values by using the “+” and “-” keys in >Upper threshold Entries< and in >Lower threshold Entries< each of which is used to trigger an alarm e-mail.

Define the threshold values by clicking the fields and by entering numerical values. The measurement transmitter will sort the specified threshold values in decreasing order. This is made independent from the input sequence.

In >Hysteresis (abs.)< and >Hysteresis (rel.)< values can be specified by clicking and typing. The measurement transmitter evaluates both values and sends an e-mail on reaching the highest top limit (highest possible value) and the lowest bottom value (lowest possible value). This mail includes the information that the alert is cancelled.

Default settings:

Hysteresis (abs.): any value can be set, manual input while setting the analog input parameters

Hysteresis (rel.): 5,0 %

Moreover, the >Alert on error< option can be checked causing an active ongoing alert to send an alarm e-mail. Possible errors are cable breaks, interruptions, short circuits etc.

43.1 Menu >Alert< / >Analog Input 3<

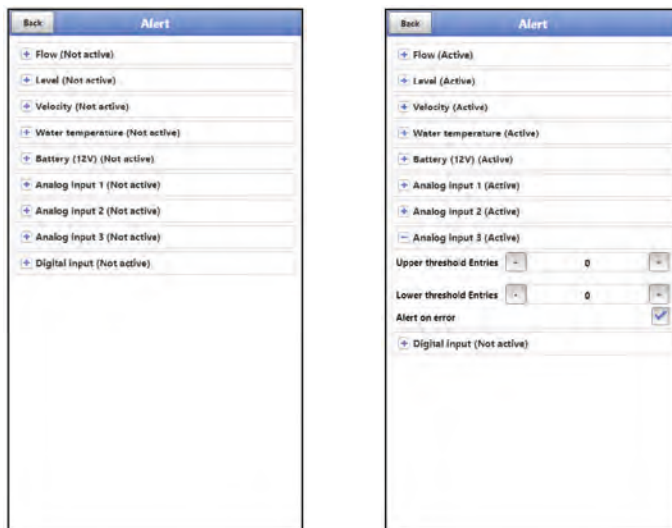

Fig. 43-8 Analog Input 3

The >Analog Input 3< subsection permits to specify up to five different limit values by using the “+” and “-” keys in >Upper threshold Entries< and in >Lower threshold Entries< each of which is used to trigger an alarm e-mail.

Define the threshold values by clicking the fields and by entering numerical values. The measurement transmitter will sort the specified threshold values in decreasing order. This is made independent from the input sequence.

In >Hysteresis (abs.)< and >Hysteresis (rel.)< values can be specified by clicking and typing. The measurement transmitter evaluates both values and sends an e-mail on reaching the highest top limit (highest possible value) and the lowest bottom value (lowest possible value). This mail includes the information that the alert is cancelled.

Default settings:

Hysteresis (abs.): any value can be set, manual input while setting the analog input parameters
Hysteresis (rel.): 5,0 %

Moreover, the >Alert on error< option can be checked causing an active ongoing alert to send an alarm e-mail. Possible errors are cable breaks, interruptions, short circuits etc.

43.1 Menu >Alert< / >Digital Input<

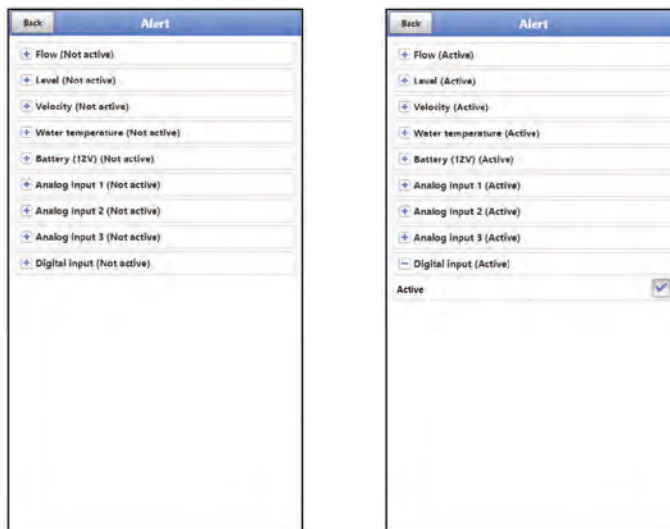
**Fig. 43-9 Digital Input**

Click the >Digital Input< checkbox in order to activate alarm e-mails in case of digital “Highs” on the digital input.

Default setting: unchecked

Diagnostics

44 Diagnostics Menu Principles



Fig. 44-1 Diagnostics Menu

The >Diagnostics< menu can be found in the >Application< menu and is split into six sub-menus.

This menu and all its submenus are read-only and simulation menus.

This section permits to view or to simulate settings on the areas below:

- h-Sensors
- v-Sensors
- Inputs/Outputs
- Flow profile
- Signal analysis
- Simulation



Observe the safety information on simulation

Necessarily observe the safety information on simulation on page 129.

45 Diagnostics Menu h-Sensors

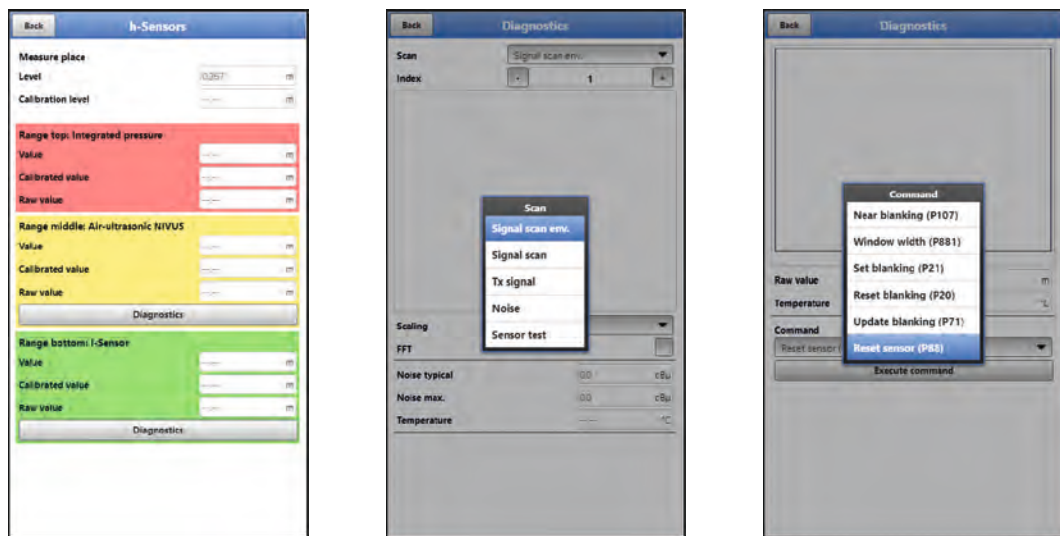

Fig. 45-1 Menu Diagnostics h-Sensors

This menu has a relation to the menu >Applications</>h-Sensors<. Depending on the type and number of sensors defined here the sections are indicated in the corresponding colours.

➡ See chapter “36.2 Setting Parameters in Menu h-Sensors”.

The Diagnostics screen shows the current level and the shaft level. The adjustment height can be set and must be confirmed with OK. The adjustment height is equal to the offset and is normally specified when the h-sensor parameters are set.

Depending on which sensors are selected the value, the calibrated value or the raw value are indicated.

- Value: issued value
- Calibrated value: corrected used value
- Raw value: real measured value

Moreover, it is possible to indicate information on “Signal scan env.”, “Signal scan”, “Tx signal”, “Noise” and “Sensor test” (depending on the connected/selected sensor type) if required.

Various commands such as “Near blanking”, “Window width”, “Set blanking”, “Reset blanking”, “Update blanking” and “Reset sensor” can be selected and executed in this menu as well.

46 Diagnostics Menu v-Sensors

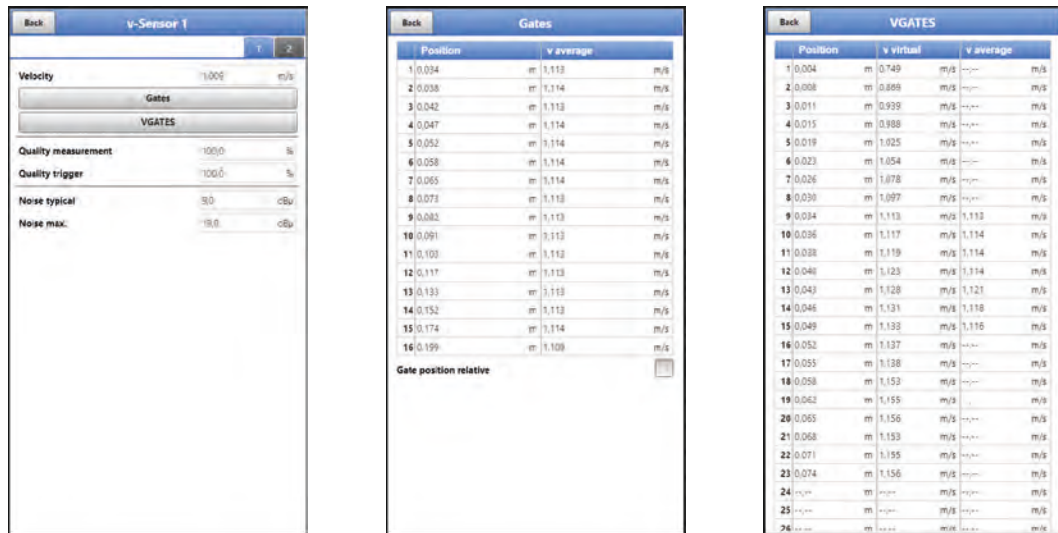

Fig. 46-1 Menu Diagnostics v-Sensors

This menu is required only for analytical purposes.

In case of errors or problems with the cross correlation measurement various factors can be used in order to determine the cause.

The following points are shown:

- **>Velocity<**
Indicates the current flow velocity (calculated from the various discrete gates).
- **>Gates<**
Indicates the average flow velocity of individual gates (for velocity calculation).
- **>VGATES<**
Indicates the virtual and average individual flow velocities and their positions.
- **>Quality measurement<**
Relevant for NIVUS commissioning and service personnel.
- **>Quality trigger<**
Relevant for NIVUS commissioning and service personnel.
- **>Noise typical<**
Information on sensor cable installation (interference); relevant for NIVUS commissioning and service personnel.
- **>Noise max.<**
Information on sensor cable installation (interference); relevant for NIVUS commissioning and service personnel.

47 Diagnostics Menu Inputs and Outputs

47.1 Important Information on the Simulation

DANGER



Personal injury and damage caused by improper simulation handling

The simulation will directly affect following plant sections. Disregarding may lead to personal injury or damage your facility.

The simulation shall be executed by trained electricians only who shall have sound knowledge on the entire control procedures of the according facility.

Prepare the simulation process carefully!

- Switch the following systems to manual operation.
- Disable actuating drives and similar or limit the according functions.

It is absolutely necessary to have a safety person available!

DANGER



Effects on plant sections

The simulation of NivuFlow Mobile outputs will directly affect any following plant sections without any safety locking measures.

Observe the hints contained within the above warning!



Important Note

NIVUS herewith in advance refuse any responsibility for any possible damage to persons or objects at any extent due to the extremely high risk of danger and unforeseeable consequences in the event of incorrect or faulty simulation!

This menu is divided in analog inputs, analog outputs, digital inputs and digital outputs.

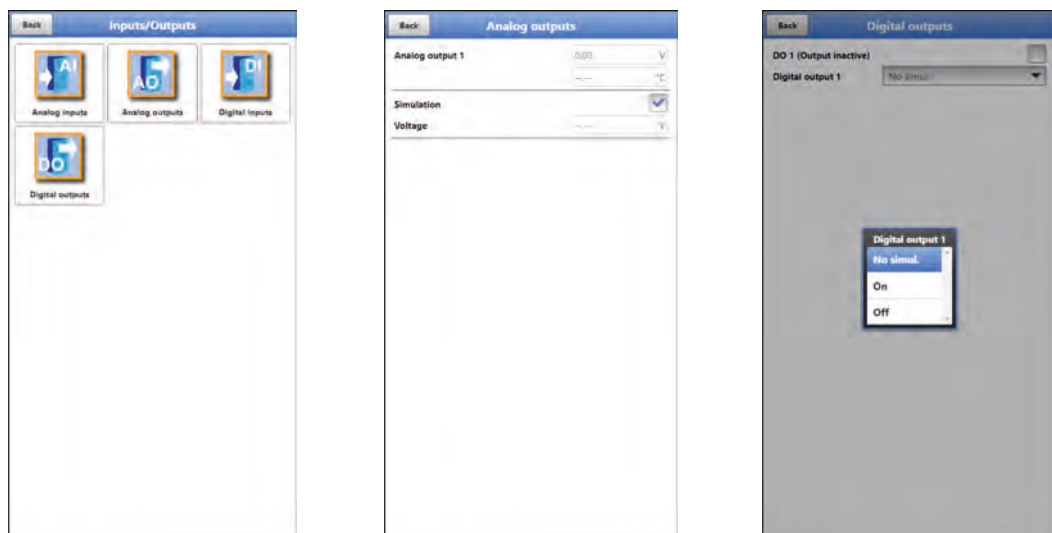

Fig. 47-1 Menu Inputs/Outputs

- **>Analog Inputs<**
Indicates the current values available at the according analog inputs.
- **>Analog Outputs<**
Indicates the available voltage values and the detected medium temperature. By checking the Simulation box it is possible to simulate a voltage (Fig. 47-1).

Necessarily observe the previous safety information on the simulation and the possible risks (effects on following plant sections) on page 129!

- **>Digital Inputs<**
Signals oncoming at the digital inputs are indicated by a checked/unchecked box.
- **>Digital Outputs<**
Active digital outputs are checked.



Actual state of relay

The actual state of the real relay cannot be indicated, but only the signal transmitted to the relay.

This menu cannot be used to obtain information on external faulty wiring.

A **Simulation** of the digital output can be executed by either selecting >No Simulation<, >On< or >Off< (Fig. 47-1).

Necessarily observe the previous safety information on the simulation and the possible risks (effects on following plant sections) on page 129!

48 Diagnostics Menu Flow profile

The graphic flow profile in the diagnostics menu is a read-only indication.

Select from the following views:

- Perspective
- Top view
- Front view
- Side view

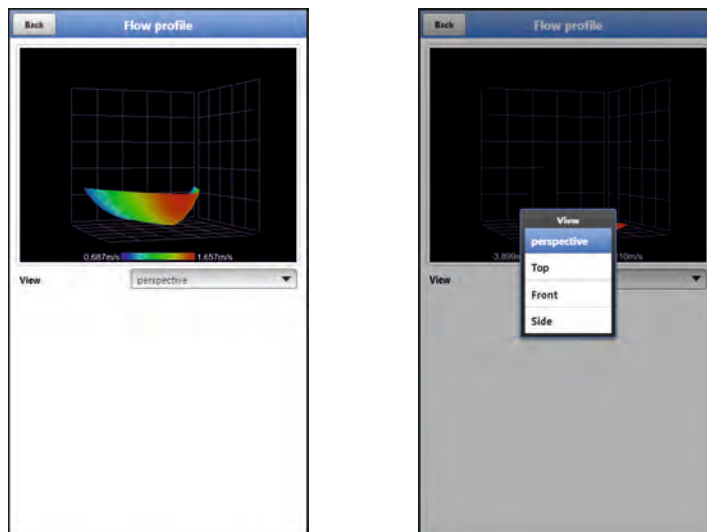

Fig. 48-1 Menu Diagnostics Flow profile

The graphic flow profile is calculated following hydraulic methods.

The factors below are taken into account while calculating the flow profile:

- Individual velocities
- Individual levels
- Channel profile
- Channel dimensions

By using more than one flow velocity sensor the quality of this graph can be improved. Horizontal hydraulic disturbances become visible as well.

49 Diagnostics Menu Signal Analysis

This menu is used to scan and to review the incoming signal from the sensor. Moreover the sensor function can be tested here.

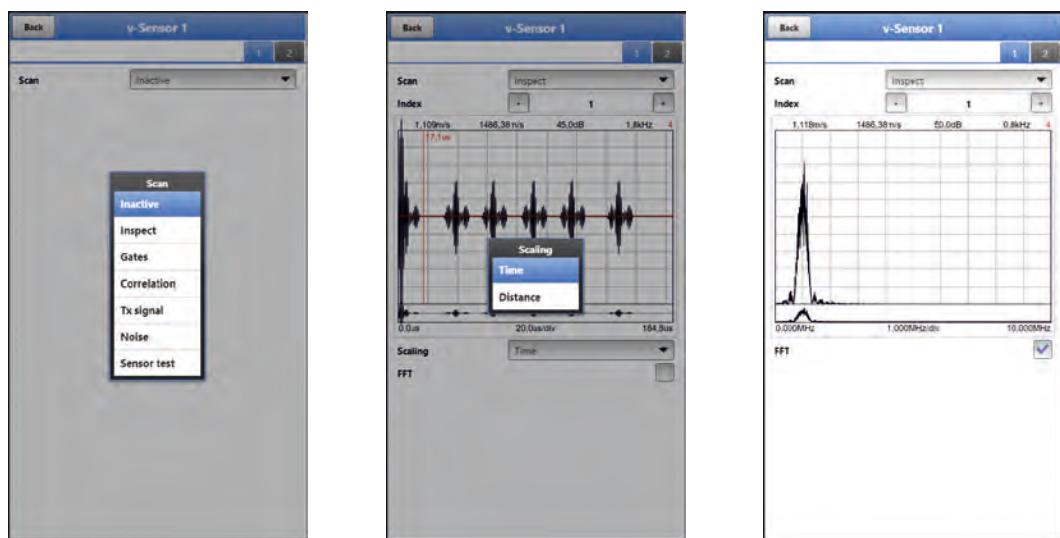

Fig. 49-1 Signal analysis menu / Inspect

Select from the options below:

- **>Inactive<**
No signal scan/evaluation
- **>Inspect<**
(Coarse) signal scan based on customer settings and possibly extended ranges.
 - **>Index<**: Subsections 1...8
 - **>Scaling<** of chart: Time or Distance
 - **>FFT<**: for frequency spectrum display; if the box is checked the graph cannot be scaled.
- **>Gates<**
Indication of the signals of the 16 gates with higher resolution.
 - **>Index<**: Gates 1...16
 - **>Scaling<** of chart: Time or Distance
 - **>FFT<**: for frequency spectrum display; if the box is checked the graph cannot be scaled.

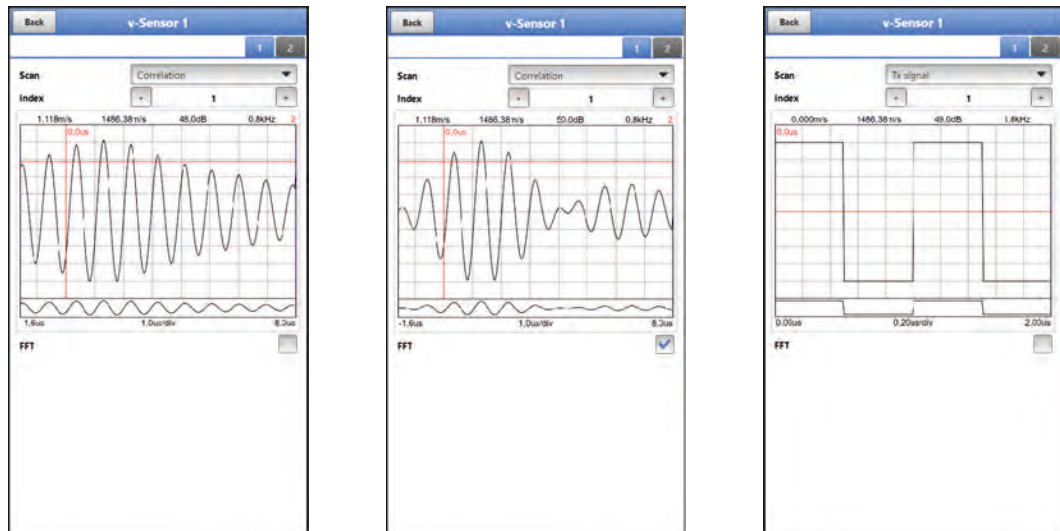

Fig. 49-2 Signal analysis Correlation / Tx signal

- **>Correlation<**
Visual comparison of both signals
 - >Index<: Gates 1...16
 - >FFT<: for frequency spectrum display
- **>Tx signal<**
Visual representation/signal shape
 - >Index<: Subsections 1...8
 - >FFT<: for frequency spectrum display
- **>Noise<**
Indication of unwanted background noise with signal evaluation
 - >FFT<: for frequency spectrum display

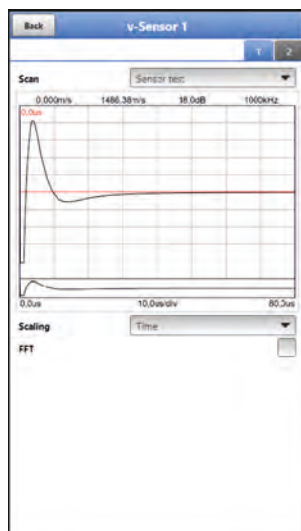

Fig. 49-3 Signal analysis Sensor test

- **>Sensor test<**
Functional test of the connected sensor, detects obstacles such as air or sedimentation.
 - >Scaling< of chart: Time or Distance
 - >FFT<: for frequency spectrum display; if the box is checked the graph cannot be scaled.

50 Simulation

DANGER



Effects on plant sections

The simulation of NivuFlow Mobile outputs will directly affect any following plant sections without any safety locking measures.

Observe the hints contained within the warning on page 129!

Stop the simulation with "Back".

This menu allows simulation of theoretical flow. Simulation is carried out by entering assumed level and velocity values. These values do **not** really exist.

Use either the >--<, >-<, >+< or >++< fields to enter smaller steps or specify absolute values (higher steps) directly in the >Velocity< field.

- = Decreases the level by 0.01 m or the velocity by 0.01 m/s per step
- = Decreases the level by 0.001 m or the velocity by 0.001 m/s per step
- + = Increases the level by 0.001 m or the velocity by 0.001 m/s per step
- ++ = Increases the level by 0.01 m or the velocity by 0.01 m/s per step

By using the simulated values (based on the channel dimension parameters set) NivuFlow Mobile calculates the prevailing flow.

Choosing >Flow< automatically indicates the calculated value.

>DO 1< shows the currently selected function.

The >Analog Output< option will output the voltage at the previously determined output.



Fig. 50-1 Simulation

Maintenance and Cleaning

WARNING



Disconnect instrument from mains power

Disconnect the instrument from mains power and safeguard the higher system against restart before you begin maintenance works.

Disregarding may lead to electric shocks.

WARNING



Check danger due to explosive gases

Make sure to observe all regulations regarding safety at work as well as danger due to explosive gases prior to beginning mounting, installation and maintenance works. Use a gas warner.

When working in channel systems make sure to avoid electrostatic charge:

- *Avoid unnecessary movements to minimise the risk of static energy accumulating.*
- *Discharge any possible static electricity from your body before you begin to install the sensor.*

Disregarding may lead to personal injury or damage your facility.

WARNING



Germ contamination possible

Due to being frequently used in wastewater applications, some portions of the measurement system may be loaded with hazardous germs. This is why precautionary measures shall be taken while being in contact with cables and sensors.

Wear protective clothing.

51 Maintenance

51.1 Maintenance Interval

The Type NivuFlow Mobile transmitters are conceived to be virtually free of calibration, maintenance and wear.

NIVUS, however, recommend having the entire measurement system inspected by the NIVUS customer service **once per year**.

Depending on the area of use the maintenance intervals may vary. Extent and intervals of maintenance depend on the following conditions:

- Measurement principle of sensors
- Material wear
- Measurement medium and hydraulic conditions
- General regulations for the operators of the measurement facility
- Ambient conditions

In addition to the annual inspection NIVUS recommends a complete maintenance of the measurement system by the NIVUS customer service after **ten years the latest**.

In general, the inspection of instruments/sensors is a basic measure which helps to increase operational safety as well as the lifetime.

51.2 Customer Service Information

For annual inspection of the entire measurement system or complete maintenance after ten years the latest contact our customer service:

NIVUS GmbH - Customer Service

Phone +49 (0) 7262 9191 - 922

Customercenter@nivus.com

52 Cleaning

52.1 Transmitter

WARNING



Disconnect instrument from mains power

Observe to disconnect the transmitter from mains power.

Disregarding may induce the risk of electrical shocks.

DANGER



Danger due to electrostatic discharge

Clean the device only with a damp cloth.

Disregarding invalidates the device's explosion protection due to possible static charge.

In such a case the unit poses a threat to the user's life and may cause an ignition in an explosive atmosphere.

When closed and locked the NivuFlow Mobile enclosure complies with IP68 protection degree and hence is less sensitive. Do **not** use high-pressure cleaners however.

Do **not** use sharp cleansing agents or solvents. Light household cleaners or soapy water can be used instead.

52.2 Power Adapter / Battery Charger

Clean power adapter/battery charger and charging tray only with a **slightly damp** cloth. The components are not protected against the ingress of moisture.

52.3 Sensors

Information on how to maintain and to clean the sensors shall be necessarily observed. Such information can be found in the according technical description or instruction manual.

Technical descriptions or instruction manuals are part of the sensor delivery.

53 Dismantling/Disposal

Improper disposal may be harmful to the environment.

- Always dispose equipment components and packaging materials according to applicable local regulations on environmental standards for electronic products:
 1. Disconnect the instrument from mains power.
 2. Remove connected cables.
 3. Remove batteries and if defect dispose accordingly.
 4. Remove the transmitter's buffer battery and separately dispose accordingly.



EC WEEE-Directive

This symbol indicates that the Directive 2012/19/EU on waste electrical and electronic equipment requirements shall be observed on the disposal of the equipment. NIVUS GmbH supports and promotes the recycling and environmentally friendly, separate collection/disposal of waste electrical and electronic equipment in order to protect the environment and human health. Observe the local disposal regulations and laws.

NIVUS GmbH is registered with the EAR, therefore public collection and return points in Germany can be used for disposal.

The unit contains a buffer battery (Lithium coin cell), which must be disposed separately.

54 Installation of spare parts and parts subject to wear and tear

We herewith particularly emphasise that replacement parts or accessories not supplied by NIVUS moreover are not certified and approved by NIVUS too. Installation and/or the use of such products hence may negatively influence predetermined constructional characteristics of the measurement system or even lead to instrument failures.

NIVUS cannot be held responsible for any damage resulting due to the use of non-original parts and non-original accessories.

55 Accessories

NFM0 ZAPB 1215	Rechargeable battery pack with sockets; nominal voltage: 12 V; capacity: 15 Ah
NFM0 ZAPB 1215 E	Rechargeable battery pack with sockets for NFM with ATEX approval zone 1; nominal voltage: 12 V; capacity: 15 Ah
NFM0 ZLAD	Power adapter/battery charger for NFM / NFM battery pack; supply voltage: 100...240 V AC, 50/60 Hz
NFM0 ZVER PS	2-wire connection cable for external power supply connection to NFM (one side with plug for multifunction socket, other side with open cable ends); cable length 5 m
NFM0 ZAB 01	Display and operation module for NFM: IP67-certified 8" outdoor tablet; resolution: 1280x800; operating system: Android; device communication: WLAN; other communication modes: USB, Bluetooth, modem 2G, 3G and 4G
NFM0 ZVER AA	Connection cable, NFM analog output (one side with plug for multifunction socket, other side with open cable ends); cable length 10 m
NFM0 ZVER AEA	Connection cable, NFM analog input; supplied by NFM (one side with plug for multifunction socket, other side with open cable ends); cable length 10 m

<i>NFM0 ZVER AEP</i>	Connection cable, NFM analog input; external power supply (one side with plug for multifunction socket, other side with open cable ends); cable length 10 m
<i>NFM0 ZVER DE</i>	Connection cable, NFM digital input (one side with plug for multifunction socket, other side with open cable ends); cable length 10 m
<i>NFM0 ZVER DA</i>	Connection cable, NFM relay output (one side with plug for multifunction socket, other side with open cable ends); cable length 10 m
<i>NFM0 ZVER NLM</i>	Connection cable between NFM and NivuLog Easy (one side with plug for multifunction socket, other side with open cable ends); cable length 5 m
<i>NFM0 ZVS1</i>	Connector Box, IP67 with NFM connection plug for connection to NFM
<i>ZUB0 KAB NMC 10</i>	2-pole, preconfigured cable with open cable ends for connection to Connector Box; cable length 10 m
<i>ZUB0 KAB NMC 20</i>	2-pole, preconfigured cable with open cable ends for connection to Connector Box; cable length 20 m
<i>ZUB0 KAB NMC 30</i>	2-pole, preconfigured cable with open cable ends for connection to Connector Box; cable length 30 m
<i>NFM0 ZAB2 VKK</i>	Adapter box for velocity measurement using 3 flow velocity sensors with NFM 750
<i>NFM0 ZSBL IRE</i>	Hoop guards (pair), for protection of connection sockets and to fasten the Connector Box on the NFM
<i>NFM0 ZHAK NFM 01</i>	Suspension bracket to fasten the NFM on step irons incl. brackets for suspension of sensor cables; material: stainless steel 1.4571
<i>NFM0 ZHAK NFM 02</i>	Suspension bracket to fasten the NFM on step irons; material: stainless steel 1.4571
<i>NFM5 GUMMI PUFFER</i>	Rubber buffers, set of 4 pcs.
<i>NFM0 Z ANT1</i>	NFM GPRS T-Shape antenna Ex-It GSM/3G, cable length 2.5 m, for connection to NFM with GPRS data remote transmission
<i>ZUB0 NFM SCHLOSS</i>	Padlock for Ex-version transmitter (to secure the device when used in Ex areas)
<i>BSL0 EP 220-20</i>	EnerPro 220 Tr / 20kA, overvoltage protection for power lines
<i>BSL0 EP 220-5</i>	EnerPro 220 Tr / 5kA, overvoltage protection for power lines
<i>BSL0 DP 2X12/12</i>	DataPro 2x1-12V/12V-11H- μ Tr(N), 20.000 A leakage current, 2-wired for sensor lines

You can find more accessories in the valid NIVUS price list.

Index

A	Accessories 136	H	h suppressed76
	Alarm 118		h-crit.....88
	Alert56, 68		h-crit automatic88
	Android operating system.....45		h-manual.....88
	Antenna43		Hoop guards21
	Approvals 141	I	
B			Indication of Capacity
	Buffer battery16, 105, 136		Battery115
C			Installation32
	Certificates141		iOS
	Channel profiles69		Operating system48
	Cleaning 135	L	
	Codes 140		Liability disclaimer17
	Colour code		Licenses140
	Wires 11		Low-flow75
	Connector box41	M	
	Copyright3		Maintenance interval134
	Correlation		Measurement principle25
	Simulation 132	N	
	Credits140		Names3
	Customer Service135		Noise
D			Simulation132
	Damping76	O	
	Delivery.....20		Operating system
	Device identification24		Android.....45
	Device types26		iOS48
E			Windows.....51
	Enclosure25		Operating temperature25
	Error messages56, 65, 106		Overvoltage protection40
	Ex approvals.....25	P	
	Explosive gases 15, 134		Parts subject to wear and tear.....136
F			Power supply25
	Flow profile		Powerdown.....107
	Diagnostics 130		Precautions.....15
G			Product construction.....22
	Germs.....16		Product overview22
	GPRS 110		Property rights3
	Antenna.....43		Protection degree 33, 135
	DNS111	Q	
	E-Mail.....113		Q suppressed76
	FTP112		Questions concerning licenses.....140
	Modem state 110		Quick Start..... 56, 59, 67, 116
	MQTT112		
	SIM-Card.....111		

R		W	
	Reception inspection.....20		Waking up
	Repeatedly measure the same measurement places.....57		Android.....45
	Restart.....107		iOS.....48
	Return.....21		Windows.....52
	Rubber buffers.....21, 137		Warranty.....16
S			Windows
	Safeguards.....15		Operating system.....51
	Sensor test		Wires
	Simulation.....132		Colour code.....11
	Sensor type.....38, 82		WLAN.....109
	Service level.....107		
	Signal analysis		
	Simulation.....131		
	Simulation		
	Important information.....129		
	Sludge level.....75		
	Spare parts.....136		
	Stability.....77		
	Stickers.....21, 32		
	Storage.....21		
	Storage temperature.....25		
	System time.....105		
T			
	Translation.....3		
	Transport.....21		
	T-Shape antenna.....43		
	Tx signal		
	Simulation.....132		
U			
	USB Stick.....59, 100		
	Use in accordance with the requirements.....17		
	User's responsibilities.....19		
V			
	v suppressed.....76		
	v-crit.....88		
	v-Determination Automatic.....88		
	v-manual.....88		
	v-Maximum.....89		
	v-Minimum.....89		

Credits and Licenses

56 List of references of the licenses and codes used

The transmitter type NivuFlow uses code of the following Open Source Projects:

- Freetype (<http://www.freetype.org>)
- Libharu (<http://libharu.org>)
- Libjpeg (<http://www.ijg.org>)
- Libpng (<http://www.libpng.org>)
- Zlib (<http://www.zlib.net>)
- Mini-XML (<http://www.msweet.org>)
- Nano-X/nxlib (<http://www.microwindows.org>)
- FLTK (<http://www.fltk.org>)
- Appendix1: LGPL
- Appendix2: MPL



Questions concerning licenses

If you have any questions concerning licenses refer to opensource@nivus.com

Approvals and Certificates

DE / EN / FR

EU Konformitätserklärung

EU Declaration of Conformity
Déclaration de conformité UE

Für das folgend bezeichnete Erzeugnis:
For the following product:
Le produit désigné ci-dessous:

Bezeichnung:	Portabler Durchflussmessumformer/-datenlogger, Standardausführung NivuFlow Mobile / NivuLevel Mobile
<i>Description:</i>	<i>Portable flow measurement transmitter/data logger, standard version NivuFlow Mobile / NivuLevel Mobile</i>
<i>Désignation:</i>	<i>Débitmètre/enregistreur de données portable, version standard NivuFlow Mobile / NivuLevel Mobile</i>
Typ / Type:	NFM0xxx00 00

erklären wir in alleiniger Verantwortung, dass die auf dem Unionsmarkt ab dem Zeitpunkt der Unterzeichnung bereitgestellten Geräte die folgenden einschlägigen Harmonisierungsvorschriften der Union erfüllen:
we declare under our sole responsibility that the equipment made available on the Union market as of the date of signature of this document meets the standards of the following applicable Union harmonisation legislation:
nous déclarons, sous notre seule responsabilité, à la date de la présente signature, la conformité du produit pour le marché de l'Union, aux directives d'harmonisation de la législation au sein de l'Union:

- 2014/53/EU
- 2011/65/EU

Bei der Bewertung wurden folgende einschlägige harmonisierte Normen zugrunde gelegt bzw. wird die Konformität erklärt in Bezug auf die nachfolgend genannten anderen technischen Spezifikationen:
The evaluation assessed the following applicable harmonised standards or the conformity is declared in relation to other technical specifications listed below:
L'évaluation est effectuée à partir des normes harmonisées applicables ou la conformité est déclarée en relation aux autres spécifications techniques désignées ci-dessous:

- EN 61010-1:2010
- EN 62311:2008
- EN 61326-1:2013
- Draft ETSI EN 301 489-1 V2.2.0
- Draft ETSI EN 301 489-17 V3.2.0
- EN 300 440 V2.1.1 (WLAN)
- EN 301 893 V2.1.1 (WLAN)

Diese Erklärung wird verantwortlich für den Hersteller:
This declaration is submitted on behalf of the manufacturer:
Le fabricant assume la responsabilité de cette déclaration:

NIVUS GmbH
Im Taele 2
75031 Eppingen
Allemagne

abgegeben durch / *represented by / faite par:*
Marcus Fischer (Geschäftsführer / *Managing Director / Directeur général*)

Eppingen, den 11.12.2018

Gez. *Marcus Fischer*



NIVUS GmbH
Im Taele 2
75031 Eppingen

Telefon: +49 07262 9191-0
Telefax: +49 07262 9191-999
E-Mail: info@nivus.com
Internet: www.nivus.de

DE / EN / FR

EU Konformitätserklärung

EU Declaration of Conformity

Déclaration de conformité UE



NIVUS GmbH
Im Taele 2
75031 Eppingen

Telefon: +49 07262 9191-0
Telefax: +49 07262 9191-999
E-Mail: info@nivus.com
Internet: www.nivus.de

Für das folgend bezeichnete Erzeugnis:

For the following product:

Le produit désigné ci-dessous:

Bezeichnung:	"Ex" Portabler Durchflussmessumformer/-datenlogger, Standardausführung NivuFlow Mobile / NivuLevel Mobile
<i>Description:</i>	<i>"Ex" Portable flow measurement transmitter/data logger, standard version NivuFlow Mobile / NivuLevel Mobile</i>
<i>Désignation:</i>	<i>"Ex" Débitmètre/enregistreur de données portable, version standard NivuFlow Mobile / NivuLevel Mobile</i>
Typ / Type:	NFM0xxxE 00

erklären wir in alleiniger Verantwortung, dass die auf dem Unionsmarkt ab dem Zeitpunkt der Unterzeichnung bereitgestellten Geräte die folgenden einschlägigen Harmonisierungsvorschriften der Union erfüllen:

we declare under our sole responsibility that the equipment made available on the Union market as of the date of signature of this document meets the standards of the following applicable Union harmonisation legislation:

nous déclarons, sous notre seule responsabilité, à la date de la présente signature, la conformité du produit pour le marché de l'Union, aux directives d'harmonisation de la législation au sein de l'Union:

- 2014/53/EU
- 2014/34/EU
- 2011/65/EU

Bei der Bewertung wurden folgende einschlägige harmonisierte Normen zugrunde gelegt bzw. wird die Konformität erklärt in Bezug auf die nachfolgend genannten anderen technischen Spezifikationen:

The evaluation assessed the following applicable harmonised standards or the conformity is declared in relation to other technical specifications listed below:

L'évaluation est effectuée à partir des normes harmonisées applicable ou la conformité est déclarée en relation aux autres spécifications techniques désignées ci-dessous:

- EN 61010-1:2010
- Draft ETSI EN 301 489-1 V2.2.0
- EN 300 328 V2.1.1 (WLAN)
- EN 60079-0:2012/A11:2013
- EN 60079-18:2015
- EN 62311:2008
- Draft ETSI EN 301 489-17 V3.2.0
- EN 301 893 V2.1.1 (WLAN)
- EN 60079-7:2015
- EN 61326-1:2013
- EN 300 440 V2.1.1 (WLAN)
- EN 60079-11:2012

Ex-Kennzeichnung / *Ex-designation / Marquage Ex :*

 II 2G Ex eb ib [ib] mb IIB T4 Gb

EU-Baumusterprüfbescheinigung / *EU-Type Examination Certificate / Attestation d'examen «UE» de type:*

TÜV 17 ATEX 196722 X issue: 01

Notifizierte Stelle (Kennnummer) / *Notified Body (Identif. No.) / Organisme notifié (N° d'identification)*

TÜV NORD CERT GmbH, Langemarckstraße 20, 45141 Essen, Germany

(0044)

Diese Erklärung wird verantwortlich für den Hersteller:

This declaration is submitted on behalf of the manufacturer:

Le fabricant assume la responsabilité de cette déclaration:

NIVUS GmbH
Im Taele 2
75031 Eppingen
Allemagne

abgegeben durch / *represented by / faite par:*

Marcus Fischer (Geschäftsführer / *Managing Director / Directeur général*)

Eppingen, den 11.03.2020

Gez. *Marcus Fischer*

DE / EN / FR

EU Konformitätserklärung

EU Declaration of Conformity

Déclaration de conformité UE



NIVUS GmbH
Im Täle 2
75031 Eppingen

Telefon: +49 07262 9191-0
Telefax: +49 07262 9191-999
E-Mail: info@nivus.com
Internet: www.nivus.de

Für das folgend bezeichnete Erzeugnis:

For the following product:

Le produit désigné ci-dessous:

Bezeichnung:	Portabler Durchflussmessumformer/-datenlogger mit internem Modem zur Datenfernübertragung über GPRS/UMTS/LTE NivuFlow Mobile/NivuLevel Mobile
<i>Description:</i>	<i>Portable flow measurement transmitter/data logger with internal modem for data transmission via GPRS/UMTS/LTE NivuFlow Mobile/NivuLevel Mobile</i>
<i>Désignation:</i>	<i>Débitmètre/enregistreur de données portable avec modem interne pour la transmission de données à distance via GPRS/UMTS/LTE NivuFlow Mobile/NivuLevel Mobile</i>
Typ / Type:	NFM0xxxG0 Ex

erklären wir in alleiniger Verantwortung, dass die auf dem Unionsmarkt ab dem Zeitpunkt der Unterzeichnung bereitgestellten Geräte die folgenden einschlägigen Harmonisierungsvorschriften der Union erfüllen:

we declare under our sole responsibility that the equipment made available on the Union market as of the date of signature of this document meets the standards of the following applicable Union harmonisation legislation:

nous déclarons, sous notre seule responsabilité, à la date de la présente signature, la conformité du produit pour le marché de l'Union, aux directives d'harmonisation de la législation au sein de l'Union:

- 2014/53/EU
- 2011/65/EU

Bei der Bewertung wurden folgende einschlägige harmonisierte Normen zugrunde gelegt bzw. wird die Konformität erklärt in Bezug auf die nachfolgend genannten anderen technischen Spezifikationen:

The evaluation assessed the following applicable harmonised standards or the conformity is declared in relation to other technical specifications listed below:

L'évaluation est effectuée à partir des normes harmonisées applicable ou la conformité est déclarée en relation aux autres spécifications techniques désignées ci-dessous:

- EN 61010-1:2010
- Draft ETSI EN 301 489-1 V2.2.0
- Draft ETSI EN 301 489-52 V1.1.0
- EN 300 328 V2.1.1 (WLAN)
- EN 300 440 V2.1.1 (WLAN)
- EN 301 908-1 V11.1.1 (UMTS, LTE)
- EN 301 908-13 V11.1.2 (LTE)
- EN 62311:2008
- Draft ETSI EN 301 489-17 V3.2.0
- EN 61326-1:2013
- EN 301 893 V2.1.1 (WLAN)
- EN 301 511 V12.5.1 (GSM)
- EN 301 908-2 V11.1.2 (UMTS)

Diese Erklärung wird verantwortlich für den Hersteller:

This declaration is submitted on behalf of the manufacturer:

Le fabricant assume la responsabilité de cette déclaration:

NIVUS GmbH
Im Täle 2
75031 Eppingen
Allemagne

abgegeben durch / *represented by / faite par:*

Marcus Fischer (Geschäftsführer / *Managing Director / Directeur général*)

Eppingen, den 11.12.2018

Gez. *Marcus Fischer*

DE / EN / FR

EU Konformitätserklärung

EU Declaration of Conformity

Déclaration de conformité UE



NIVUS GmbH
Im Taele 2
75031 Eppingen

Telefon: +49 07262 9191-0
Telefax: +49 07262 9191-999
E-Mail: info@nivus.com
Internet: www.nivus.de

Für das folgend bezeichnete Erzeugnis:

For the following product:

Le produit désigné ci-dessous:

Bezeichnung:	Portabler Durchflussmessumformer/-datenlogger mit internem Modem zur Datenfernübertragung über GPRS/UMTS/LTE NivuFlow Mobile/NivuLevel Mobile
<i>Description:</i>	<i>Portable flow measurement transmitter/data logger with internal modem for data transmission via GPRS/UMTS/LTE NivuFlow Mobile/NivuLevel Mobile</i>
<i>Désignation:</i>	<i>Débitmètre/enregistreur de données portable avec modem interne pour la transmission de données à distance via GPRS/UMTS/LTE NivuFlow Mobile/NivuLevel Mobile</i>
Typ / Type:	NFM0xxxG0 Gx

erklären wir in alleiniger Verantwortung, dass die auf dem Unionsmarkt ab dem Zeitpunkt der Unterzeichnung bereitgestellten Geräte die folgenden einschlägigen Harmonisierungsvorschriften der Union erfüllen:

we declare under our sole responsibility that the equipment made available on the Union market as of the date of signature of this document meets the standards of the following applicable Union harmonisation legislation:

nous déclarons, sous notre seule responsabilité, à la date de la présente signature, la conformité du produit pour le marché de l'Union, aux directives d'harmonisation de la législation au sein de l'Union:

- 2014/53/EU
- 2011/65/EU

Bei der Bewertung wurden folgende einschlägige harmonisierte Normen zugrunde gelegt bzw. wird die Konformität erklärt in Bezug auf die nachfolgend genannten anderen technischen Spezifikationen:

The evaluation assessed the following applicable harmonised standards or the conformity is declared in relation to other technical specifications listed below:

L'évaluation est effectuée à partir des normes harmonisées applicable ou la conformité est déclarée en relation aux autres spécifications techniques désignées ci-dessous:

- EN 61010-1:2010
- Draft ETSI EN 301 489-1 V2.2.0
- Draft ETSI EN 301 489-52 V1.1.0
- EN 300 328 V2.1.1 (WLAN)
- EN 300 440 V2.1.1 (WLAN)
- EN 301 908-1 V11.1.1 (UMTS, LTE)
- EN 301 908-13 V11.1.2 (LTE)
- EN 62311:2008
- Draft ETSI EN 301 489-17 V3.2.0
- EN 61326-1:2013
- EN 301 893 V2.1.1 (WLAN)
- EN 301 511 V12.5.1 (GSM)
- EN 301 908-2 V11.1.2 (UMTS)

Diese Erklärung wird verantwortlich für den Hersteller:

This declaration is submitted on behalf of the manufacturer:

Le fabricant assume la responsabilité de cette déclaration:

NIVUS GmbH
Im Taele 2
75031 Eppingen
Allemagne

abgegeben durch / *represented by / faite par:*

Marcus Fischer (Geschäftsführer / *Managing Director / Directeur général*)

Eppingen, den 11.03.2020

Gez. *Marcus Fischer*

DE / EN / FR

EU Konformitätserklärung

EU Declaration of Conformity

Déclaration de conformité UE

Für das folgend bezeichnete Erzeugnis:

For the following product:

Le produit désigné ci-dessous:



NIVUS GmbH
Im Taele 2
75031 Eppingen

Telefon: +49 07262 9191-0
Telefax: +49 07262 9191-999
E-Mail: info@nivus.com
Internet: www.nivus.de

Bezeichnung:	"Ex" Portabler Durchflussmessumformer/-datenlogger, mit internem Modem zur Datenfernübertragung über GPRS/UMTS/LTE NivuFlow Mobile / NivuLevel Mobile
<i>Description:</i>	<i>"Ex" Portable flow measurement transmitter/data logger, with internal modem for data transmission via GPRS/UMTS/LTE NivuFlow Mobile / NivuLevel Mobile</i>
<i>Désignation:</i>	<i>"Ex" Débitmètre/enregistreur de données portable avec modem interne pour la transmission de données à distance via GPRS/UMTS/LTE NivuFlow Mobile / NivuLevel Mobile</i>
Typ / Type:	NFM0xxxGE Ex

erklären wir in alleiniger Verantwortung, dass die auf dem Unionsmarkt ab dem Zeitpunkt der Unterzeichnung bereitgestellten Geräte die folgenden einschlägigen Harmonisierungsvorschriften der Union erfüllen:

we declare under our sole responsibility that the equipment made available on the Union market as of the date of signature of this document meets the standards of the following applicable Union harmonisation legislation:

nous déclarons, sous notre seule responsabilité, à la date de la présente signature, la conformité du produit pour le marché de l'Union, aux directives d'harmonisation de la législation au sein de l'Union:

- 2014/53/EU
- 2014/34/EU
- 2011/65/EU

Bei der Bewertung wurden folgende einschlägige harmonisierte Normen zugrunde gelegt bzw. wird die Konformität erklärt in Bezug auf die nachfolgend genannten anderen technischen Spezifikationen:

The evaluation assessed the following applicable harmonised standards or the conformity is declared in relation to other technical specifications listed below:

L'évaluation est effectuée à partir des normes harmonisées applicable ou la conformité est déclarée en relation aux autres spécifications techniques désignées ci-dessous:

- EN 61010-1:2010
- Draft ETSI EN 301 489-1 V2.2.0
- Draft ETSI EN 301 489-52 V1.1.0
- EN 300 440 V2.1.1 (WLAN)
- EN 301 908-1 V11.1.1 (UMTS, LTE)
- EN 60079-0:2012/A11:2013
- EN 60079-18:2015
- EN 62311:2008
- Draft ETSI EN 301 489-17 V3.2.0
- EN 300 328 V2.1.1 (WLAN)
- EN 301 511 V12.5.1 (GSM)
- EN 301 908-2 V11.1.2 (UMTS)
- EN 60079-7:2015
- EN 61326-1:2013
- EN 301 893 V2.1.1 (WLAN)
- EN 301 908-13 V11.1.2 (LTE)
- EN 60079-11:2012

Ex-Kennzeichnung / *Ex-designation / Marquage Ex* :

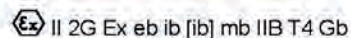

EU-Baumusterprüfbescheinigung / *EU-Type Examination Certificate / Attestation d'examen «UE» de type:*

TÜV 17 ATEX 196722 X issue: 01

Notifizierte Stelle (Kennnummer) / *Notified Body (Identif. No.) / Organisme notifié (N° d'identification)*

TÜV NORD CERT GmbH, Langemarkstraße 20, 45141 Essen, Germany

(0044)

Diese Erklärung wird verantwortlich für den Hersteller:

This declaration is submitted on behalf of the manufacturer:

Le fabricant assume la responsabilité de cette déclaration:

NIVUS GmbH
Im Taele 2
75031 Eppingen
Allemagne

abgegeben durch / *represented by / faite par:*

Marcus Fischer (Geschäftsführer / *Managing Director / Directeur général*)

Eppingen, den 11.03.2020

Gez. *Marcus Fischer*

DE / EN / FR

EU Konformitätserklärung

EU Declaration of Conformity

Déclaration de conformité UE

Für das folgend bezeichnete Erzeugnis:

For the following product:

Le produit désigné ci-dessous:



NIVUS GmbH
Im Taele 2
75031 Eppingen

Telefon: +49 07262 9191-0
Telefax: +49 07262 9191-999
E-Mail: info@nivus.com
Internet: www.nivus.de

Bezeichnung:	"Ex" Portabler Durchflussmessumformer/-datenlogger, mit internem Modem zur Datenfernübertragung über GPRS/UMTS/LTE NivuFlow Mobile / NivuLevel Mobile
<i>Description:</i>	<i>"Ex" Portable flow measurement transmitter/data logger, with internal modem for data transmission via GPRS/UMTS/LTE NivuFlow Mobile / NivuLevel Mobile</i>
<i>Désignation:</i>	<i>"Ex" Débitmètre/enregistreur de données portable avec modem interne pour la transmission de données à distance via GPRS/UMTS/LTE NivuFlow Mobile / NivuLevel Mobile</i>
Typ / Type:	NFM0xxxGE Gx

erklären wir in alleiniger Verantwortung, dass die auf dem Unionsmarkt ab dem Zeitpunkt der Unterzeichnung bereitgestellten Geräte die folgenden einschlägigen Harmonisierungsvorschriften der Union erfüllen:

we declare under our sole responsibility that the equipment made available on the Union market as of the date of signature of this document meets the standards of the following applicable Union harmonisation legislation:

nous déclarons, sous notre seule responsabilité, à la date de la présente signature, la conformité du produit pour le marché de l'Union, aux directives d'harmonisation de la législation au sein de l'Union:

- 2014/53/EU
- 2014/34/EU
- 2011/65/EU

Bei der Bewertung wurden folgende einschlägige harmonisierte Normen zugrunde gelegt bzw. wird die Konformität erklärt in Bezug auf die nachfolgend genannten anderen technischen Spezifikationen:

The evaluation assessed the following applicable harmonised standards or the conformity is declared in relation to other technical specifications listed below:

L'évaluation est effectuée à partir des normes harmonisées applicable ou la conformité est déclarée en relation aux autres spécifications techniques désignées ci-dessous:

- EN 61010-1:2010
- Draft ETSI EN 301 489-1 V2.2.0
- Draft ETSI EN 301 489-52 V1.1.0
- EN 300 440 V2.1.1 (WLAN)
- EN 301 908-1 V11.1.1 (UMTS, LTE)
- EN 60079-0:2012/A11:2013
- EN 60079-18:2015
- EN 62311:2008
- Draft ETSI EN 301 489-17 V3.2.0
- EN 300 328 V2.1.1 (WLAN)
- EN 301 511 V12.5.1 (GSM)
- EN 301 908-2 V11.1.2 (UMTS)
- EN 60079-7:2015
- EN 61326-1:2013
- EN 301 893 V2.1.1 (WLAN)
- EN 301 908-13 V11.1.2 (LTE)
- EN 60079-11:2012

Ex-Kennzeichnung / *Ex-designation / Marquage Ex* :

 II 2G Ex eb ib [ib] mb IIB T4 Gb

EU-Baumusterprüfbescheinigung / *EU-Type Examination Certificate / Attestation d'examen «UE» de type:*

TÜV 17 ATEX 196722 X issue: 01

Notifizierte Stelle (Kennnummer) / *Notified Body (Identif. No.) / Organisme notifié (N° d'identification)*

TÜV NORD CERT GmbH, Langemarkstraße 20, 45141 Essen, Germany

(0044)

Diese Erklärung wird verantwortlich für den Hersteller:

This declaration is submitted on behalf of the manufacturer:

Le fabricant assume la responsabilité de cette déclaration:

NIVUS GmbH
Im Taele 2
75031 Eppingen
Allemagne

abgegeben durch / *represented by / faite par:*

Marcus Fischer (Geschäftsführer / *Managing Director / Directeur général*)

Eppingen, den 11.03.2020

Gez. *Marcus Fischer*

DE / EN / FR

EU Konformitätserklärung

EU Declaration of Conformity

Déclaration de conformité UE



NIVUS GmbH
Im Taele 2
75031 Eppingen

Telefon: +49 07262 9191-0
Telefax: +49 07262 9191-999
E-Mail: info@nivus.com
Internet: www.nivus.de

Für das folgend bezeichnete Erzeugnis:

For the following product:

Le produit désigné ci-dessous:

Bezeichnung:	Ladeschale NFM
<i>Description:</i>	<i>charging station NFM</i>
<i>Désignation:</i>	<i>station de charge NFM</i>
Typ / Type:	NFM02 LADESCH

erklären wir in alleiniger Verantwortung, dass die auf dem Unionsmarkt ab dem Zeitpunkt der Unterzeichnung bereitgestellten Geräte die folgenden einschlägigen Harmonisierungsvorschriften der Union erfüllen:

we declare under our sole responsibility that the equipment made available on the Union market as of the date of signature of this document meets the standards of the following applicable Union harmonisation legislation:

nous déclarons, sous notre seule responsabilité, à la date de la présente signature, la conformité du produit pour le marché de l'Union, aux directives d'harmonisation de la législation au sein de l'Union:

- 2011/65/EU

Bei der Bewertung wurden folgende einschlägige harmonisierte Normen zugrunde gelegt bzw. wird die Konformität erklärt in Bezug die nachfolgend genannten anderen technischen Spezifikationen:

The evaluation assessed the following applicable harmonised standards or the conformity is declared in relation to other technical specifications listed below:

L'évaluation est effectuée à partir des normes harmonisées applicables ou la conformité est déclarée en relation aux autres spécifications techniques désignées ci-dessous:

- EN 50581:2012

Diese Erklärung wird verantwortlich für den Hersteller:

This declaration is submitted on behalf of the manufacturer:

Le fabricant assume la responsabilité de cette déclaration:

NIVUS GmbH
Im Taele 2
75031 Eppingen
Allemagne

abgegeben durch / *represented by / faite par:*

Marcus Fischer (Geschäftsführer / *Managing Director / Directeur général*)

Eppingen, den 08.02.2018

Gez. *Marcus Fischer*



Translation

(1) **EU-Type Examination Certificate**

- (2) Equipment and protective systems intended for use in potentially explosive atmospheres, **Directive 2014/34/EU**



(3) **Certificate Number** TÜV 17 ATEX 196722 X **issue:** 01

(4) for the product: Portable Measuring Transformer
NivuFlow Mobile Typ NFM-0xxx x E and
NivuLevel Mobile Typ NFM-0050 x E

(5) of the manufacturer: NIVUS GmbH

(6) Address: Im Täle 2
75031 Eppingen

Order number: 8003009451

Date of issue: 2019-10-28

- (7) The design of this product and any acceptable variation thereto are specified in the schedule to this EU-Type Examination Certificate and the documents therein referred to.

- (8) The TÜV NORD CERT GmbH, Notified Body No. 0044, in accordance with Article 17 of the Directive 2014/34/EU of the European Parliament and the Council of 26 February 2014, certifies that this product has been found to comply with the Essential Health and Safety Requirements relating to the design and construction of products intended for use in potentially explosive atmospheres given in Annex II to the Directive.
The examination and test results are recorded in the confidential ATEX Assessment Report No. 19 203 251874.

- (9) Compliance with the Essential Health and Safety Requirements has been assured by compliance with:

EN 60079-0:2012+A11:2013 EN 60079-11:2012 EN 60079-7:2015
EN 60079-18:2015

except in respect of those requirements listed at item 18 of the schedule.

- (10) If the sign "X" is placed after the certificate number, it indicates that the product is subject to the Specific Conditions for Use specified in the schedule to this certificate.

- 11) This EU-Type Examination Certificate relates only to the design, and construction of the specified product. Further requirements of the Directive apply to the manufacturing process and supply of this equipment. These are not covered by this certificate.

- (12) The marking of the product shall include the following:

 II 2 G Ex eb ib [ib] mb IIB T4 Gb

TÜV NORD CERT GmbH, Langemarckstraße 20, 45141 Essen, notified by the central office of the countries for safety engineering (ZLS), Ident. Nr. 0044, legal successor of the TÜV NORD CERT GmbH & Co. KG Ident. Nr. 0032

The head of the notified body



Rodér

Hanover office, Am TÜV 1, 30519 Hannover, Tel. +49 511 998-61455, Fax +49 511 998-61590

This certificate may only be reproduced without any change, schedule included.
Excerpts or changes shall be allowed by the TÜV NORD CERT GmbH



(13) **SCHEDULE**

(14) **EU-Type Examination Certificate No. TÜV 17 ATEX 196722 X issue 01**

(15) Description of product

Together with the belonging sensors, the Portable Measuring Transformer NivuFlow Mobile type NFM-0xxx x E and NivuLevel Mobile type NFM-0050 x E are used for the measurement of the flow speed and the flow level in partly or fully filled pipes and channels via supersonic technology. The Portable Measuring Transformer NivuFlow Mobile/NivuLevel Mobile type NFM... is operated stationary.

The permissible ambient temperature range is -15 °C ... +50 °C.

Electrical data

Supply voltage $U_n = 12 \text{ V d. c.}$
 (Internal plug connections) Powered with max. 2 x 12 V/15Ah VRLA-Pb-batteries;

External supply circuit in type of protection Intrinsic Safety Ex ib IIB
 (X1R [Uin], Only for connection to an intrinsically safe circuit
 X1B [GND]) Maximum values:
 $U_i = 14.5 \text{ V}$
 $I_i = 1.25 \text{ A}$
 $P_i = 18.1 \text{ W}$
 The effective internal capacitances and inductances are negligibly small.

1 wire circuit in type of protection Intrinsic Safety Ex ib IIB
 (CSM connector X10E [GND], Maximum values:
 X10F [1 wire];
 DSM connector X8E [GND], X8F [1 wire]) $U_o = 3.7 \text{ V}$
 $I_o = 57.3 \text{ mA}$
 $P_o = 53 \text{ mW}$
 Characteristic line: linear

Ex ib	IIB		
	max. permissible external inductance	65 mH	10 mH
max. permissible external capacitance	9.4 µF	21 µF	37 µF

5 V circuit in type of protection Intrinsic Safety Ex ib IIB
 (CSM connector X10E [GND], Maximum values:
 X10J [+5 V-Ex];
 DSM connector $U_o = 5.93 \text{ V}$
 X8E [GND], X8J [+5 V-Ex]) $I_o = 91.7 \text{ mA}$
 $P_o = 135.9 \text{ mW}$
 Characteristic line: linear

Ex ib	IIB		
	max. permissible external inductance	1 mH	0.2 mH
max. permissible external capacitance	14 µF	23 µF	30 µF



Schedule to EU-Type Examination Certificate No. TÜV 17 ATEX 196722 X issue 01

RS485 interface pressure, output in type of protection Intrinsic Safety Ex ib IIB
(CSM connector X10G [- RxTx], X10H [+ RxTx]) Maximum values:

$U_o = 3.7 \text{ V}$
 $I_o = 95.1 \text{ mA}$
 $P_o = 88 \text{ mW}$
Characteristic line: linear

Ex ib	IIB		
max. permissible external inductance	25 mH	10 mH	1 mH
max. permissible external capacitance	11 μF	18 μF	36 μF

RS485 interface pressure, input in type of protection Intrinsic Safety Ex ib IIB
(CSM connector X10G [- RxTx], X10H [+ RxTx]) Only for connection to an intrinsically safe circuit
Maximum values:

$U_i = 7.21 \text{ V}$
 $I_i = 176 \text{ mA}$
 $P_i = 317.2 \text{ mW}$
The effective internal capacitances and inductances are negligibly small.

Radar sensor supply in type of protection Intrinsic Safety Ex ib IIB
(Connector X1A, X1B) Maximum values:

$U_o = 9.87 \text{ V}$
 $I_o = 629 \text{ mA}$
 $P_o = 6.21 \text{ W}$
Characteristic line: rectangular

Ex ib	IIB		
max. permissible external inductance	0.2 mH	0.1 mH	0.05 mH
max. permissible external capacitance	5 μF	8 μF	11.9 μF

RS485 interface, output in type of protection Intrinsic Safety Ex ib IIB
(Connector X1C, X1D) Maximum values:

$U_o = 3.7 \text{ V}$
 $I_o = 95.1 \text{ mA}$
 $P_o = 88 \text{ mW}$
Characteristic line: linear

Ex ib	IIB		
max. permissible external inductance	25 mH	10 mH	1 mH
max. permissible external capacitance	11 μF	18 μF	36 μF



Schedule to EU-Type Examination Certificate No. TÜV 17 ATEX 196722 X issue 01

RS485 interface, input in type of protection Intrinsic Safety Ex ib IIB
 (Connector X1C, X1D) Only for connection to an intrinsically safe circuit
 Maximum values:
 $U_i = 10.21 \text{ V}$
 $I_i = 248.8 \text{ mA}$
 $P_i = 633.8 \text{ mW}$
 The effective internal capacitances and inductances are negligibly small.

Analogue input no. 1 /2 in type of protection Intrinsic Safety Ex ib IIB
 (Connector X1G, X1F; X1H, X1J) Maximum values:
 NivuLevel Mobile type NFM-0050 x E: $U_o = 22.2 \text{ V}$
 Connector X7C, X7E; X7B, X7D) $I_o = 33 \text{ mA}$
 $R = 48 \text{ } \Omega$
 $P_o = 624 \text{ mW}$
 Characteristic line: trapezoidal

Ex ib	IIB		
max. permissible external inductance	20 mH	1 mH	0.1 mH
max. permissible external capacitance	0.52 μF	0.56 μF	1 μF

Analogue input no. 3 in type of protection Intrinsic Safety Ex ib IIB
 (Connector X1K, X1M) Maximum values:
 $U_o = 3.7 \text{ V}$
 $I_o = <1 \text{ mA}$
 $P_o = <1 \text{ mW}$
 Characteristic line: linear

Ex ib	IIB		
max. permissible external inductance	100 mH	10 mH	1 mH
max. permissible external capacitance	19 μF	24 μF	38 μF

Analogue input no. 3 in type of protection Intrinsic Safety Ex ib IIB
 (Connector X1K, X1M) Only for connection to an intrinsically safe circuit
 Maximum values:
 $U_i = 5.53 \text{ V}$
 $I_i = 33.5 \text{ mA}$
 $P_i = 185.4 \text{ mW}$
 The effective internal capacitances and inductances are negligibly small.



Schedule to EU-Type Examination Certificate No. TÜV 17 ATEX 196722 X issue 01

Analogue output in type of protection Intrinsic Safety Ex ib IIB
(Connector X1L, X1M)
Maximum values:
 $U_o = 15.78 \text{ V}$
 $I_o = 177.4 \text{ mA}$
 $P_o = 700 \text{ mW}$
Characteristic line: linear

Ex ib	IIB		
	max. permissible external inductance	5.5 mH	1 mH
max. permissible external capacitance	1 μF	2.4 μF	2.6 μF

Digital input in type of protection Intrinsic Safety Ex ib IIB
(Connector X1N, X1P)
Maximum values:
 $U_o = 3.7 \text{ V}$
 $I_o = < 1 \text{ mA}$
 $P_o = < 1 \text{ mW}$
Characteristic line: linear

Ex ib	IIB		
	max. permissible external inductance	100 mH	1 mH
max. permissible external capacitance	19 μF	38 μF	81 μF

Digital input in type of protection Intrinsic Safety Ex ib IIB
(Connector X1N, X1P)
Only for connection to an intrinsically safe circuit
Maximum values:
 $U_i = 19.69 \text{ V}$
 $I_i = 4.23 \text{ mA}$
 $P_i = 83.3 \text{ mW}$
The effective internal capacitances and inductances are negligibly small.

Piezo circuits in type of protection Intrinsic Safety Ex ib IIB
(CSM connector X10 A/B and C/D,
DSM connector X8 A/B and C/D)
Only for connection
to the belonging sensors of the manufacturer
Max. output energy: 146 μJ

Relay output in type of protection Intrinsic Safety Ex ib IIB
(Connector X1S, X1T, X1U)
Only for connection to an intrinsically safe circuit
Maximum values:
 $U_i = 26 \text{ V}$
 $I_i = 100 \text{ mA}$
 $P_i = 2.6 \text{ W}$
The effective internal capacitances and inductances are negligibly small.



Schedule to EU-Type Examination Certificate No. TÜV 17 ATEX 196722 X issue 01

SIM-card circuit in type of protection Intrinsic Safety Ex ib IIB
 (SIM-CARD connector) Maximum values:
 $U_o = 4.5 \text{ V}$
 $I_o = 283 \text{ mA}$
 $P_o = 319 \text{ mW}$
 Characteristic line: linear

Ex ib	IIB		
	max. permissible external inductance	1 mH	0.1 mH
max. permissible external capacitance	21 μF	51 μF	120 μF

The rules for interconnection of intrinsically safe circuits have to be observed.

(16) Drawings and documents are listed in the ATEX Assessment Report No. 19 203 251874.

(17) Specific Conditions for Use

1. Electrostatic charge has to be avoided for all housing parts and the interlock; the manual of the manufacturer has to be observed.
2. Charging of the supply batteries is only permitted outside of the explosion hazardous area with the charger of the manufacturer or with a separately certified charger (intrinsically safe charge circuit); the manual of the manufacturer has to be observed.
3. Change of the supply batteries / backup battery is only permitted outside of the explosion hazardous area.
4. Only permissible batteries according to the manufacturer's operating instructions are allowed to be used.
5. The memory stick is only permitted to be used outside of the explosion hazardous area at the USB port.
6. The change of the SIM card is only permitted outside of the explosion hazardous area. See "Electrical data" for operation in the explosion hazardous area.
7. Operation is only allowed in vertical position (plug-connectors downwards).
8. The housing has to be additionally secured by an interlock provided by the manufacturer.
9. The battery in the right-hand housing part (connections MP1/MP2) is not allowed to be connected, if the external power supply is used.
10. The connections at X8 are only permissible for use of the manufacturer for firmware-updates in the safe area.



(18) Essential Health and Safety Requirements

no additional ones

- End of Certificate -

		IECEX Certificate of Conformity	
INTERNATIONAL ELECTROTECHNICAL COMMISSION IEC Certification System for Explosive Atmospheres <small>for rules and details of the IECEX Scheme visit www.iecex.com</small>			
Certificate No.:	IECEX TUN 18.0008X	Page 1 of 4	<u>Certificate history:</u> Issue 0 (2018-07-27)
Status:	Current	Issue No: 1	
Date of Issue:	2019-11-13		
Applicant:	NIVUS GmbH Im Tälle 2, 75031 Eppingen Germany		
Equipment:	Portable Measuring Transformer NivuFlow Mobile type NFM-0xxx x E, NivuLevel Mobile type NFM-0050 x E		
Optional accessory:			
Type of Protection:	Increased safety "e", intrinsic safety "i", encapsulation "m"		
Marking:	Ex eb Ib [Ib] mb IIB T4 Gb		
Approved for issue on behalf of the IECEX Certification Body:	Christian Roder		
Position:	Head of the IECEX Certification Body		
Signature: (for printed version)			
Date:	2019-11-13		
<ol style="list-style-type: none">1. This certificate and schedule may only be reproduced in full.2. This certificate is not transferable and remains the property of the issuing body.3. The Status and authenticity of this certificate may be verified by visiting www.iecex.com or use of this QR Code.			
Certificate issued by: TÜV NORD CERT GmbH Hanover Office Am TÜV 1, 30519 Hannover Germany			

		<h2>IECEX Certificate of Conformity</h2>	
Certificate No.:	IECEX TUN 18.0008X	Page 2 of 4	
Date of Issue:	2019-11-13	Issue No: 1	
Manufacturer:	NIVUS GmbH Im Täle 2, 75031 Eppingen Germany		
Additional manufacturing locations:			
<p>This certificate is issued as verification that a sample(s), representative of production, was assessed and tested and found to comply with the IEC Standard list below and that the manufacturer's quality system, relating to the Ex products covered by this certificate, was assessed and found to comply with the IECEx Quality system requirements. This certificate is granted subject to the conditions as set out in IECEx Scheme Rules, IECEx 02 and Operational Documents as amended</p>			
<p>STANDARDS : The equipment and any acceptable variations to it specified in the schedule of this certificate and the identified documents, was found to comply with the following standards</p>			
IEC 60079-0:2011	Explosive atmospheres - Part 0: General requirements		
Edition:6.0			
IEC 60079-11:2011	Explosive atmospheres - Part 11: Equipment protection by intrinsic safety "i"		
Edition:6.0			
IEC 60079-18:2014	Explosive atmospheres – Part 18: Equipment protection by encapsulation "m"		
Edition:4.0			
IEC 60079-7:2015	Explosive atmospheres – Part 7: Equipment protection by increased safety "e"		
Edition:5.0			
<p>This Certificate does not indicate compliance with safety and performance requirements other than those expressly included in the Standards listed above.</p>			
<p>TEST & ASSESSMENT REPORTS: A sample(s) of the equipment listed has successfully met the examination and test requirements as recorded in:</p>			
Test Report:			
	DE/TUN/EXTR18.0013/00		
Quality Assessment Report:			
	DE/TUN/QAR13.0011/06		

		IECEX Certificate of Conformity
Certificate No.:	IECEX TUN 18.0008X	Page 3 of 4
Date of issue:	2019-11-13	Issue No: 1
EQUIPMENT: Equipment and systems covered by this Certificate are as follows:		
Together with the belonging sensors, the "Portable Measuring Transformer"		
NivuFlow Mobile type NFM-0xxx x E and		
NivuLevel Mobile type NFM-0050 x E		
are used for the measurement of the flow speed and the flow level in partly or fully filled pipes and channels via supersonic technology.		
The Portable Measuring Transformer type NivuFlow Mobile NFM is operated stationary.		
The permissible ambient temperature range is -15 °C ... +50 °C.		
For further information, see attachment.		
SPECIFIC CONDITIONS OF USE: YES as shown below:		
<ol style="list-style-type: none">1. Electrostatic charge has to be avoided for all housing parts and the interlock; the manual of the manufacturer has to be observed.2. Charging of the supply batteries is only permitted outside of the explosion hazardous area with the charger of the manufacturer or with a separately certified charger (Intrinsically safe charge circuit); the manual of the manufacturer has to be observed.3. Change of the supply batteries / backup battery is only permitted outside of the explosion hazardous area.4. Only permissible batteries according to the manufacturer's operating instructions are allowed to be used.5. The memory stick is only permitted to be used outside of the explosion hazardous area at the USB port.6. The change of the SIM card is only permitted outside of the explosion hazardous area. See "Electrical data" for operation in the explosion hazardous area.7. Operation is only allowed in vertical position (plug-connectors downwards).8. The housing has to be additionally secured by an interlock provided by the manufacturer.9. The battery in the right-hand housing part (connections MP1/MP2) is not allowed to be connected, if the external power supply is used.10. The connections at X8 are only permissible for use of the manufacturer for firmware-updates in the safe area.		

	IECEX Certificate of Conformity
Certificate No.: IECEX TUN 18.0008X	Page 4 of 4
Date of issue: 2019-11-13	Issue No: 1
DETAILS OF CERTIFICATE CHANGES (for issues 1 and above)	
-Mechanical changes	
-Layout changes	
-Electrical data partly changed	
-Special Conditions partly changed	
-New type with less components "NivuLevel Mobile type NFM-0050 x E"	
Annex:	
Attachment _issue 1_NivuFlow Mobile.pdf	

TÜV NORD CERT GmbH
Hannover Office
Am TÜV 1
30519 Hannover
Germany



Page 1 of 5
Attachment to IECEx TUN 18.0008 X issue No.: 01

Product:

Together with the belonging sensors, the Portable Measuring Transformer NivuFlow Mobile type NFM-0xxx x E and NivuLevel Mobile type NFM-0050 x E are used for the measurement of the flow speed and the flow level in partly or fully filled pipes and channels via supersonic technology. The Portable Measuring Transformer NivuFlow Mobile/NivuLevel Mobile type NFM... is operated stationary.

The permissible ambient temperature range is -15 °C ... +50 °C.

Electrical data

Supply voltage $U_n = 12 \text{ V d. c.}$
(Internal plug connections) Powered with max. 2 x 12 V/15Ah VRLA-Pb-batteries;

External supply circuit in type of protection Intrinsic Safety Ex ib IIB
(X1R [Uin], Only for connection to an intrinsically safe circuit
X1B [GND]) Maximum values:
 $U_i = 14.5 \text{ V}$
 $I_i = 1.25 \text{ A}$
 $P_i = 18.1 \text{ W}$
The effective internal capacitances and inductances are negligibly small.

1 wire circuit in type of protection Intrinsic Safety Ex ib IIB
(CSM connector X10E [GND], Maximum values:
X10F [1 wire];
DSM connector X8E [GND], X8F [1 wire]) $U_o = 3.7 \text{ V}$
 $I_o = 57.3 \text{ mA}$
 $P_o = 53 \text{ mW}$
Characteristic line: linear

Ex ib	IIB		
	max. permissible external inductance	65 mH	10 mH
max. permissible external capacitance	9.4 μF	21 μF	37 μF

5 V circuit in type of protection Intrinsic Safety Ex ib IIB
(CSM connector X10E [GND], Maximum values:
X10J [+5 V-Ex];
DSM connector $U_o = 5.93 \text{ V}$
X8E [GND], X8J [+5 V-Ex]) $I_o = 91.7 \text{ mA}$
 $P_o = 135.9 \text{ mW}$
Characteristic line: linear

Ex ib	IIB		
	max. permissible external inductance	1 mH	0.2 mH
max. permissible external capacitance	14 μF	23 μF	30 μF

TÜV NORD CERT GmbH
 Hannover Office
 Am TÜV 1
 30519 Hannover
 Germany



Page 2 of 5
 Attachment to IECEx TUN 18.0008 X issue No.: 01

RS485 interface pressure, output in type of protection Intrinsic Safety Ex ib IIB
 (CSM connector X10G [- RxTx], X10H [+ RxTx]) Maximum values:

$U_o = 3.7 \text{ V}$
 $I_o = 95.1 \text{ mA}$
 $P_o = 88 \text{ mW}$
 Characteristic line: linear

Ex ib	IIB		
max. permissible external inductance	25 mH	10 mH	1 mH
max. permissible external capacitance	11 μF	18 μF	36 μF

RS485 interface pressure, input in type of protection Intrinsic Safety Ex ib IIB
 (CSM connector X10G [- RxTx], X10H [+ RxTx]) Only for connection to an intrinsically safe circuit
 Maximum values:

$U_i = 7.21 \text{ V}$
 $I_i = 176 \text{ mA}$
 $P_i = 317.2 \text{ mW}$
 The effective internal capacitances and inductances are negligibly small.

Radar sensor supply in type of protection Intrinsic Safety Ex ib IIB
 (Connector X1A, X1B) Maximum values:

$U_o = 9.87 \text{ V}$
 $I_o = 629 \text{ mA}$
 $P_o = 6.21 \text{ W}$
 Characteristic line: rectangular

Ex ib	IIB		
max. permissible external inductance	0.2 mH	0.1 mH	0.05 mH
max. permissible external capacitance	5 μF	8 μF	11.9 μF

RS485 interface, output in type of protection Intrinsic Safety Ex ib IIB
 (Connector X1C, X1D) Maximum values:

$U_o = 3.7 \text{ V}$
 $I_o = 95.1 \text{ mA}$
 $P_o = 88 \text{ mW}$
 Characteristic line: linear

Ex ib	IIB		
max. permissible external inductance	25 mH	10 mH	1 mH
max. permissible external capacitance	11 μF	18 μF	36 μF

TÜV NORD CERT GmbH
Hannover Office
Am TÜV 1
30519 Hannover
Germany



Page 3 of 5
Attachment to IECEx TUN 18.0008 X Issue No.: 01

RS485 interface, Input in type of protection Intrinsic Safety Ex ib IIB
(Connector X1C, X1D) Only for connection to an intrinsically safe circuit
Maximum values:
 $U_i = 10.21 \text{ V}$
 $I_i = 248.8 \text{ mA}$
 $P_i = 633.8 \text{ mW}$
The effective internal capacitances and inductances are negligibly small.

Analogue input no. 1 / 2 in type of protection Intrinsic Safety Ex ib IIB
(Connector X1G, X1F; X1H, X1J) Maximum values:
NivuLevel Mobile type NFM-0050 x E: $U_o = 22.2 \text{ V}$
Connector X7C, X7E; X7B, X7D) $I_o = 33 \text{ mA}$
 $R = 48 \text{ } \Omega$
 $P_o = 624 \text{ mW}$
Characteristic line: trapezoidal

Ex ib	IIB		
max. permissible external inductance	20 mH	1 mH	0.1 mH
max. permissible external capacitance	0.52 μF	0.56 μF	1 μF

Analogue input no. 3 in type of protection Intrinsic Safety Ex ib IIB
(Connector X1K, X1M) Maximum values:
 $U_o = 3.7 \text{ V}$
 $I_o = <1 \text{ mA}$
 $P_o = <1 \text{ mW}$
Characteristic line: linear

Ex ib	IIB		
max. permissible external inductance	100 mH	10 mH	1 mH
max. permissible external capacitance	19 μF	24 μF	38 μF

Analogue input no. 3 in type of protection Intrinsic Safety Ex ib IIB
(Connector X1K, X1M) Only for connection to an intrinsically safe circuit
Maximum values:
 $U_i = 5.53 \text{ V}$
 $I_i = 33.5 \text{ mA}$
 $P_i = 185.4 \text{ mW}$
The effective internal capacitances and inductances are negligibly small.

TÜV NORD CERT GmbH
 Hannover Office
 Am TÜV 1
 30519 Hannover
 Germany



Page 4 of 5
 Attachment to IECEx TUN 18.0008 X issue No.: 01

Analogue output (Connector X1L, X1M)	in type of protection Intrinsic Safety Ex ib IIB Maximum values: $U_o = 15.78 \text{ V}$ $I_o = 177.4 \text{ mA}$ $P_o = 700 \text{ mW}$ Characteristic line: linear												
	<table border="1"> <thead> <tr> <th>Ex ib</th> <th colspan="3">IIB</th> </tr> </thead> <tbody> <tr> <td>max. permissible external inductance</td> <td>5.5 mH</td> <td>1 mH</td> <td>0.1 mH</td> </tr> <tr> <td>max. permissible external capacitance</td> <td>1 μF</td> <td>2.4 μF</td> <td>2.6 μF</td> </tr> </tbody> </table>	Ex ib	IIB			max. permissible external inductance	5.5 mH	1 mH	0.1 mH	max. permissible external capacitance	1 μF	2.4 μF	2.6 μF
Ex ib	IIB												
max. permissible external inductance	5.5 mH	1 mH	0.1 mH										
max. permissible external capacitance	1 μF	2.4 μF	2.6 μF										
Digital input (Connector X1N, X1P)	in type of protection Intrinsic Safety Ex ib IIB Maximum values: $U_o = 3.7 \text{ V}$ $I_o = < 1 \text{ mA}$ $P_o = < 1 \text{ mW}$ Characteristic line: linear												
	<table border="1"> <thead> <tr> <th>Ex ib</th> <th colspan="3">IIB</th> </tr> </thead> <tbody> <tr> <td>max. permissible external inductance</td> <td>100 mH</td> <td>1 mH</td> <td>0.1 mH</td> </tr> <tr> <td>max. permissible external capacitance</td> <td>19 μF</td> <td>38 μF</td> <td>81 μF</td> </tr> </tbody> </table>	Ex ib	IIB			max. permissible external inductance	100 mH	1 mH	0.1 mH	max. permissible external capacitance	19 μF	38 μF	81 μF
Ex ib	IIB												
max. permissible external inductance	100 mH	1 mH	0.1 mH										
max. permissible external capacitance	19 μF	38 μF	81 μF										
Digital input (Connector X1N, X1P)	in type of protection Intrinsic Safety Ex ib IIB Only for connection to an intrinsically safe circuit Maximum values: $U_i = 19.69 \text{ V}$ $I_i = 4.23 \text{ mA}$ $P_i = 83.3 \text{ mW}$ The effective internal capacitances and inductances are negligibly small.												
Piezo circuits (CSM connector X10 A/B and C/D, DSM connector X8 A/B and C/D)	in type of protection Intrinsic Safety Ex ib IIB Only for connection to the belonging sensors of the manufacturer Max. output energy: 146 μJ												
Relay output (Connector X1S, X1T, X1U)	in type of protection Intrinsic Safety Ex ib IIB Only for connection to an intrinsically safe circuit Maximum values: $U_i = 26 \text{ V}$ $I_i = 100 \text{ mA}$ $P_i = 2.6 \text{ W}$ The effective internal capacitances and inductances are negligibly small.												

TÜV NORD CERT GmbH
Hannover Office
Am TÜV 1
30519 Hannover
Germany



Page 5 of 5
Attachment to IECEx TUN 18.0008 X issue No.: 01

SIM-card circuit in type of protection Intrinsic Safety Ex ib IIB
(SIM-CARD connector)
Maximum values:
 $U_o = 4.5 \text{ V}$
 $I_o = 283 \text{ mA}$
 $P_o = 319 \text{ mW}$
Characteristic line: linear

	IIB		
	Ex ib	0.1 mH	0.02 mH
max. permissible external inductance	1 mH	0.1 mH	0.02 mH
max. permissible external capacitance	21 μF	51 μF	120 μF

The rules for interconnection of intrinsically safe circuits have to be observed.

Special Conditions for Safe Use:

1. Electrostatic charge has to be avoided for all housing parts and the interlock; the manual of the manufacturer has to be observed.
2. Charging of the supply batteries is only permitted outside of the explosion hazardous area with the charger of the manufacturer or with a separately certified charger (intrinsically safe charge circuit); the manual of the manufacturer has to be observed.
3. Change of the supply batteries / backup battery is only permitted outside of the explosion hazardous area.
4. Only permissible batteries according to the manufacturer's operating instructions are allowed to be used.
5. The memory stick is only permitted to be used outside of the explosion hazardous area at the USB port.
6. The change of the SIM card is only permitted outside of the explosion hazardous area. See "Electrical data" for operation in the explosion hazardous area.
7. Operation is only allowed in vertical position (plug-connectors downwards).
8. The housing has to be additionally secured by an interlock provided by the manufacturer.
9. The battery in the right-hand housing part (connections MP1/MP2) is not allowed to be connected, if the external power supply is used.
10. The connections at X8 are only permissible for use of the manufacturer for firmware-updates in the safe area.