

Operating Instructions



Hand-held
Ultrasonic Flowmeter

USC X200

Arkon Flow Systems, s.r.o.

Nováčkova 11
614 00 Brno
Czech Republic

Tel. +420 543 214 822

Fax +420 543 215 249

Internet www.arkon.co.uk

E-mail arkon@arkon.co.uk

**Operating Instructions USCX200
Version V20EN140908**

USCX200 Operating Instructions

Contents

	Page
1 Safety instructions, legal requirements, warranty, return policy.....	5
1.1 Symbols used in these operating instructions.....	5
1.2 Safety instructions.....	5
1.3 Warranty.....	6
1.4 Return policy.....	6
1.5 Legislative requirements.....	6
2 Introduction.....	7
3 Installation.....	8
3.1 Unpacking and storage.....	8
3.1.1 <i>Unpacking</i>	8
3.1.2 <i>Storage and preservation</i>	8
3.1.3 <i>Identification of components</i>	8
3.2 Clamp-on sensor installation.....	9
3.3 Installation location.....	9
3.4 Pipe preparation.....	12
3.5 Clamp-on sensor mounting configurations and separation distance.....	12
3.6 Flowmeter installation.....	13
3.6.1 <i>Outline dimensions</i>	13
3.6.2 <i>Electrical connections</i>	14
3.7 Clamp-on sensor mounting.....	15
3.7.1 <i>Sensor pipe mounting configurations</i>	15
3.7.2 <i>Acoustic coupling gel</i>	15
3.7.3 <i>Correct positioning of the sensors</i>	16
3.7.4 <i>Sensor mounting with fixtures and chains</i>	16
4 Operation.....	18
4.1 Switching On/Off.....	18
4.2 Battery charging.....	18
4.3 Keypad and display.....	19
4.3.1 <i>Keypad key functions</i>	19
4.3.2 <i>Display functions</i>	21
4.4 Quick setup wizard.....	22
4.5 Measurements.....	24
4.5.1 <i>Main process value (PV) display</i>	24
4.5.2 <i>Diagnostic display</i>	25
4.5.3 <i>Totalisers</i>	25
4.5.4 <i>Datalogger</i>	25

5 Commissioning	26
5.1 Menu structure.....	26
5.2 Diagnostics.....	29
5.3 Display settings.....	29
5.3.1 <i>Main PV</i>	29
5.3.2 <i>Line 1</i>	29
5.4 Output settings.....	29
5.4.1 <i>Serial interface RS 232</i>	29
5.5 Data software.....	29
5.6 Wall thickness measurement (WTM).....	29
5.6.1 <i>Wall Thickness Gauge (WTG) Wizard</i>	30
5.7 Scope function.....	31
6 Maintenance	32
7 Troubleshooting	33
8 Technical data	35
9 Specification	41
10 Index	43
Appendix A - Certificate of Conformity	44
Appendix B - Customer Return Note (CRN)	45

1 Safety instructions, legal requirements, warranty, return policy

1.1 Symbols used in these operating instructions



Danger

This symbol represents an immediate hazardous situation which could result in **serious injury, death** or **damage to the equipment**. Where this symbol is shown, do not use the equipment further unless you have fully understood the nature of the hazard and have taken the required precautions.



Attention

This symbol indicates important instructions which should be respected in order to avoid damaging or destroying the equipment. Follow the the precautions given in these instructions to avoid the hazard. Call our service team if necessary.



Call service

Where this symbol is shown call our service team for advice if necessary.



Note

This symbol indicates a note or detailed set-up tip.



Information point.



Operator keys are printed in bold typeface and placed in pointed brackets.

1.2 Safety instructions

- Do not install, operate or maintain this flowmeter without reading, understanding and following these operating instructions, otherwise injury or damage may result.
- Study these operating instructions carefully before the installation of the equipment and keep them for future reference.
- Observe all warnings, notes and instructions as marked on the packaging, on the equipment, and detailed in the operating instructions.
- Do not use the instrument under wet conditions with the battery cover removed or opened.
- Follow the unpacking, storage and preservation instructions to avoid damage to the equipment.
- Install the equipment and cabling securely and safely according to the relevant regulations.
- If the product does not operate normally, please refer to the service and troubleshooting instructions, or contact Arkon for help.

1.3 Warranty

- This product purchased from Arkon is warranted in accordance with the relevant product documentation and as specified in the sales contract provided it has been used for the purpose for which it has been designed and operated as outlined in these operating instructions. Misuse of the equipment will immediately revoke any warranty given or implied.
- Responsibility for suitability and intended use of this ultrasonic flowmeter rests solely with the user. Improper installation and operation of the flowmeter may lead to a loss of warranty.
- Please note that there are no operator-serviceable parts inside the equipment. Any unauthorised interference with the product will invalidate the warranty.

1.4 Return policy

If the flowmeter has been diagnosed to be faulty, it can be returned to Arkon for repair using the Customer Returns Note (CRN) attached to the Appendix of this manual. Arkon regret that for Health & Safety reasons we cannot accept the return of the equipment unless accompanied by the completed CRN.

1.5 Legislative requirements

CE marking

The flowmeter is designed to meet the safety requirements in accordance with sound engineering practice. It has been tested and has left the factory in a condition in which it is safe to operate. The equipment is in conformity with the statutory requirements of the EC directive and complies with applicable regulations and standards for electrical safety EN 61010 and electro-magnetic compatibility EN 61326. A CE Declaration of Conformity has been issued in that respect, a copy of which can be found in the Appendix of these operating instructions.

WEEE Directive

The Waste Electrical and Electronic Equipment Directive (WEEE Directive) aims to minimise the impact of electrical and electronic goods on the environment by increasing re-use and recycling and by reducing the amount of WEEE going to landfill. It seeks to achieve this by making producers responsible for financing the collection, treatment, and recovery of waste electrical equipment, and by obliging distributors to allow consumers to return their waste equipment free of charge.



Arkon offers its customers the possibility of returning unused and obsolete equipment for correct disposal and recycling. The Dustbin Symbol indicates that when the last user wishes to discard this product, it must be sent to appropriate facilities for recovery and recycling. By not discarding this product along with other household-type waste, the volume of waste sent to incinerators or landfills will be reduced and natural resources will be conserved. Please use the Customer Return Note (CRN) in the Appendix for return to Arkon.

RoHS Directive

All products manufactured by Arkon are compliant with the relevant aspects of the RoHS Directive.

2 Introduction

Clamp-on transit-time flowmeter

The USCX200 is a hand-held, battery operated ultrasonic flowmeter employing clamp-on sensors for the measurement of liquids in full, enclosed pipes. Flow measurements can be undertaken without interruption of the process or interference with the integrity of the pipeline. The clamp-on sensors are attached to the outside of the pipes. The USCX200 uses ultrasonic signals for measurement of the flow, employing the transit-time method.

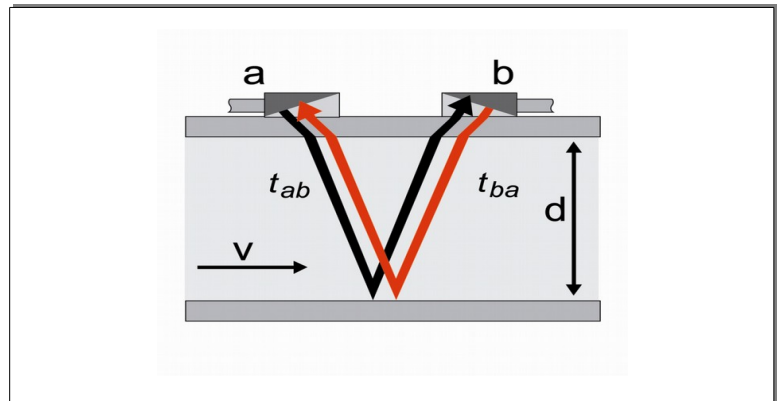

Illustration 1: Clamp-on ultrasonic flowmeter configuration

Measuring principle

Ultrasonic signals are emitted by a transducer installed on a pipe and received by a second transducer. These signals are emitted alternately in the direction of flow and against it. Because the medium is flowing, the transit time of the sound signals propagating in the direction of flow is shorter than the transit time of the signal propagating against the direction of flow. The transit-time difference ΔT is measured and allows the determination of the average flow velocity along the path of acoustic propagation. A profile correction is then performed to obtain the average flow velocity over the cross-sectional area of the pipe, which is proportional to the volumetric flow rate.

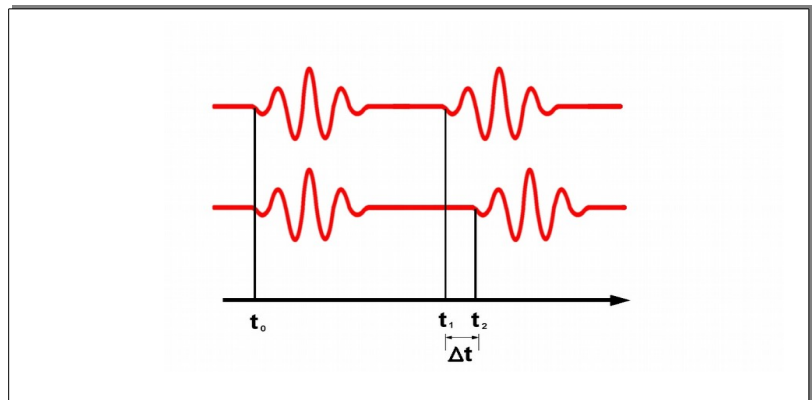

Illustration 2: Transit-time measuring principle

3 Installation

3.1 Unpacking and storage

3.1.1 Unpacking

Care should be taken when opening the box containing the flowmeter, any markings or warnings shown on the packaging should be observed prior to opening. The following steps should then be taken:

- Unpack the flowmeter in a dry area.
- The flowmeter should be handled with care and not left in an area where it could be subject to physical shocks.
- If using a knife to remove packaging care should be taken not to damage the flowmeter or cables.
- The flowmeter package and contents should be checked against the delivery note supplied and any missing items reported immediately.
- The flowmeter package and contents should be checked for signs of damage during transport and any problems reported immediately.
- The vendor accepts no responsibility for damage or injury caused during the unpacking of the instrumentation supplied.
- Excess packing materials should be either recycled or disposed of in a suitable way.

3.1.2 Storage

If storage is necessary, the flowmeter and sensors should be stored:

- in a secure location,
- away from water and harsh environmental conditions,
- in such a way as to avoid damage,
- small items should be kept together in the bags and small plastic boxes provided to avoid loss.

3.1.3 Identification of components

The following items are typically supplied (please refer to your delivery note for a detailed description):

- USCX200 hand-held flowmeter
- Clamp-on sensors (usually one or two pairs depending on pipe sizes to be measured)
- Sensor extension cable(s) (optional)
- Sensor mounting accessories
- Coupling component
- Measuring tape
- Operating instructions
- Calibration certificate(s) (optional)

3.2 Clamp-on sensor installation

The correct selection of the sensor location is crucial for achieving reliable measurements and high accuracy. Measurement must take place on a pipe in which sound can propagate (see Acoustic propagation) and in which a rotationally symmetrical flow profile is fully developed (see Straight pipe lengths).

The correct positioning of the transducers is an essential condition for error-free measurements. It ensures that the sound signal will be received under optimal conditions and evaluated correctly. Because of the variety of applications and the different factors influencing the measurement, there can be no standard solution for the positioning of the transducers.

The correct position of the transducers will be influenced by the following factors:

- diameter, material, lining, wall thickness and general condition of the pipe,
- the medium flowing in the pipe,
- the presence of gas bubbles and solid particles in the medium.

Check that the temperature at the selected location is within the operating temperature range of the transducers (see technical specification in the Appendix).

Acoustic propagation Acoustic propagation is achieved when the flowmeter is able to receive sufficient signal from the transmitted ultrasonic pulses. The signals are attenuated in the pipe material, the medium and at each of the interfaces and reflections. External and internal pipe corrosion, solid particles and gas content in the medium contribute heavily to signal attenuation.

Straight pipe lengths Sufficient straight lengths of pipe on the inlet and outlet of the measuring location ensure an axi-symmetrical flow profile in the pipe, which is required for good measurement accuracy. If insufficient straight lengths of pipe are available for your application measurements are still obtainable, but the certainty of the measurement can be reduced.

3.3 Installation location

Select an installation location following the recommendations in Table 1 and try to avoid measuring :



- in the vicinity of deformations and defects of the pipe,
- near welding seams,
- where deposits could be building up in the pipe.

For a horizontal pipe:
 Select a location where the transducers can be mounted on the side of the pipe, so that the sound waves emitted by the transducers propagate horizontally in the pipe. In this way, the solid particles deposited on the bottom of the pipe and the gas pockets developing at the top will not influence the propagation of the signal.

Correct **Incorrect**

For a free inlet or outlet pipe section:

Select the measuring point at a location where the pipe cannot run empty.

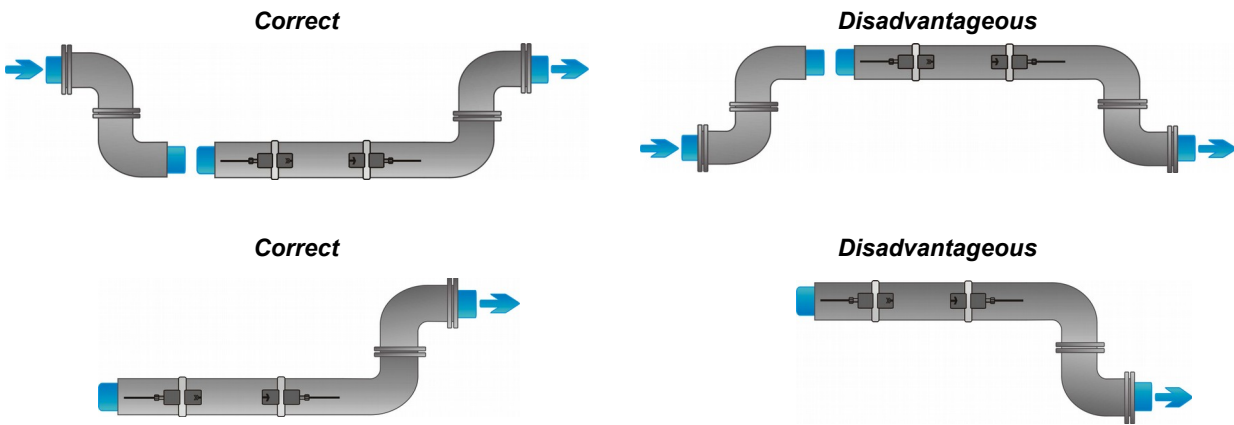

For a vertical pipe:

Select the measuring point at a location where the liquid flows upward to ensure that the pipe is completely filled.

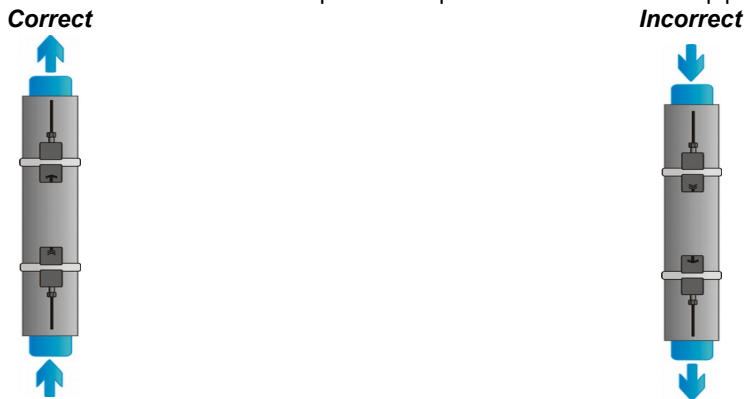

Table 1: Recommendations for sensor mounting location



Look for a sensor installation location with sufficient straight pipe to obtain accurate measurements. Please refer to Table 2 as a guideline for recommended distances from disturbance sources.

Disturbance source: 90°-elbow

Inlet

$L \geq 10 D$

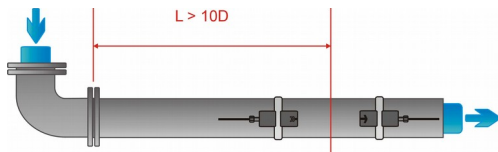

Outlet

$L \geq 5 D$

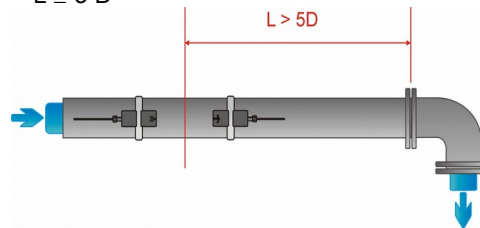

Disturbance source: 2 x 90°-elbows in one plane

Inlet

$L \geq 25 D$

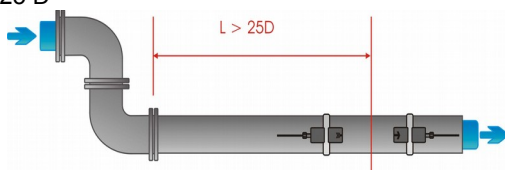

Outlet

$L > 5 D$

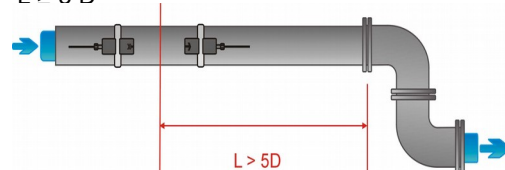

<p>Disturbance source: 2 x 90°-elbows in different planes</p>	
<p>Inlet $L \geq 40 D$</p> 	<p>Outlet $L \geq 5 D$</p> 
<p>Disturbance source: T-section</p>	
<p>Inlet $L \geq 50 D$</p> 	<p>Outlet $L \geq 10 D$</p> 
<p>Disturbance source: diffuser</p>	
<p>Inlet $L \geq 30 D$</p> 	<p>Outlet $L \geq 5 D$</p> 
<p>Disturbance source: reducer</p>	
<p>Inlet $L \geq 10 D$</p> 	<p>Outlet $L \geq 5 D$</p> 
<p>Disturbance source: valve</p>	
<p>Inlet $L \geq 40 D$</p> 	<p>Outlet $L \geq 10 D$</p> 
<p>Disturbance source: pump</p>	
<p>Inlet $L \geq 50 D$</p> 	

Table 2: Recommended distances from disturbance sources

3.4 Pipe preparation

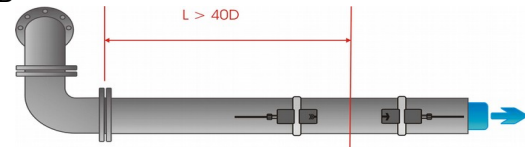
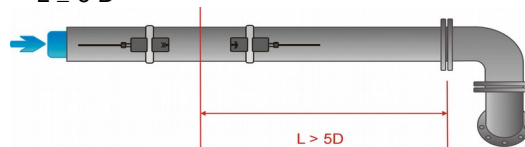
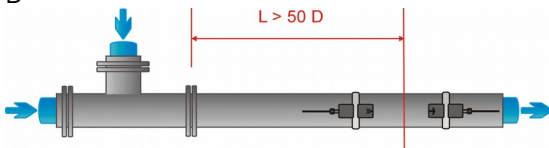
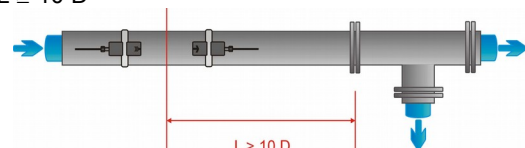
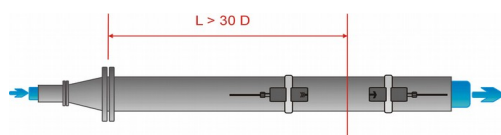
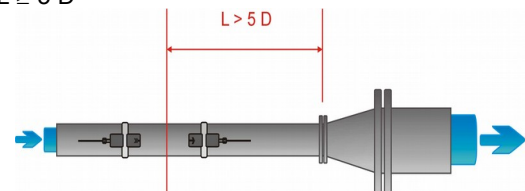
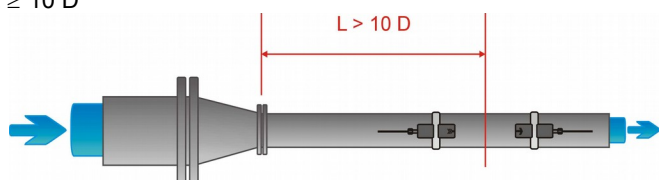
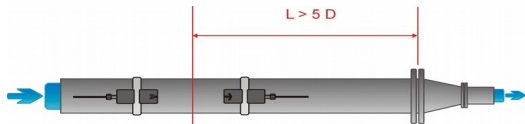
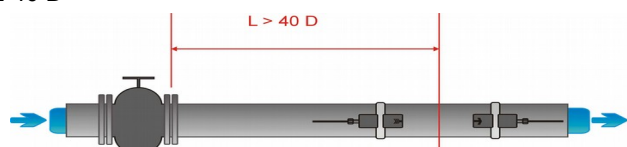
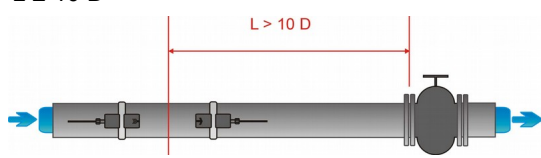
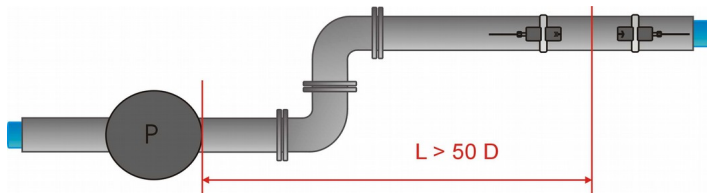

- Clean dirt and dust from around the area of the pipework where the sensors are to be placed.
- Remove loose paint and rust with a wire brush or file.

Firmly bonded paint does not necessarily need to be removed provided the flow-meter diagnostics indicate sufficient signal strength.

3.5 Clamp-on sensor mounting configurations and separation distance

Reflection Mode

The most common clamp-on sensor mounting configuration is the Reflection Mode, sometimes known as V-Mode (see Illustration 3, sketch (1)). Here, the ultrasonic signal passes twice through the medium (2 signal passes). The Reflection Mode is the most convenient mounting method as the transducer separation distance can be measured easily and the sensors can be accurately aligned. This method should be used whenever possible.

Diagonal Mode

An alternative mounting configuration (Illustration 3, sketch (3)) is the Diagonal mode (Z-Mode). The signals travel only once through the pipe. This method is often used for larger pipes where greater signal attenuation might occur.

Further variation of the Reflection and the Diagonal Modes are possible by altering the number of passes through the pipe. Any even number of passes will require mounting the sensors on the same side of the pipe, while with an odd number of passes, the sensors must be mounted on opposite sides of the pipe. Commonly, for very small pipes, sensor mounting configurations such as 4 passes (W-mode) or 3 passes (N-mode) are used (Illustration 3, sketch (2)).

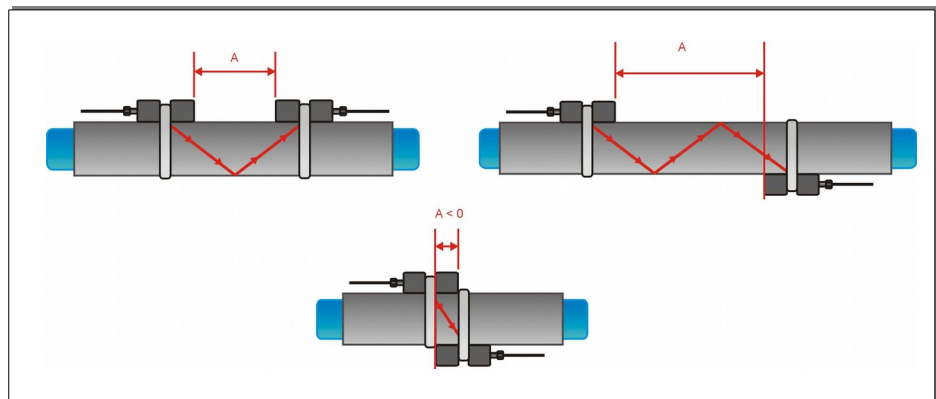

Illustration 3: Clamp-on sensor mounting configurations and sensor spacing

Transducer separation distance

The transducer separation distance A is measured from the inside edges of the sensor heads as shown in illustration 3. It is automatically calculated by the flow-meter based on the parameter entries for pipe outside diameter, wall thickness, lining material and thickness, medium, process temperature, the sensor type and the selected number of signal passes.



A negative separation distance $A < 0$ can occur for mounting configurations on small pipes where diagonal mode operation has been selected (see Illustration 3, sketch (3)). Negative separation distances may be suggested for reflection mode installations, but are not possible. In these cases, use diagonal mode or a larger number of passes.

3.6 Flowmeter installation

3.6.1 Outline dimensions

The USCX200 is a hand-held, battery operated device with the following outline dimensions.

Flowmeter outline dimensions

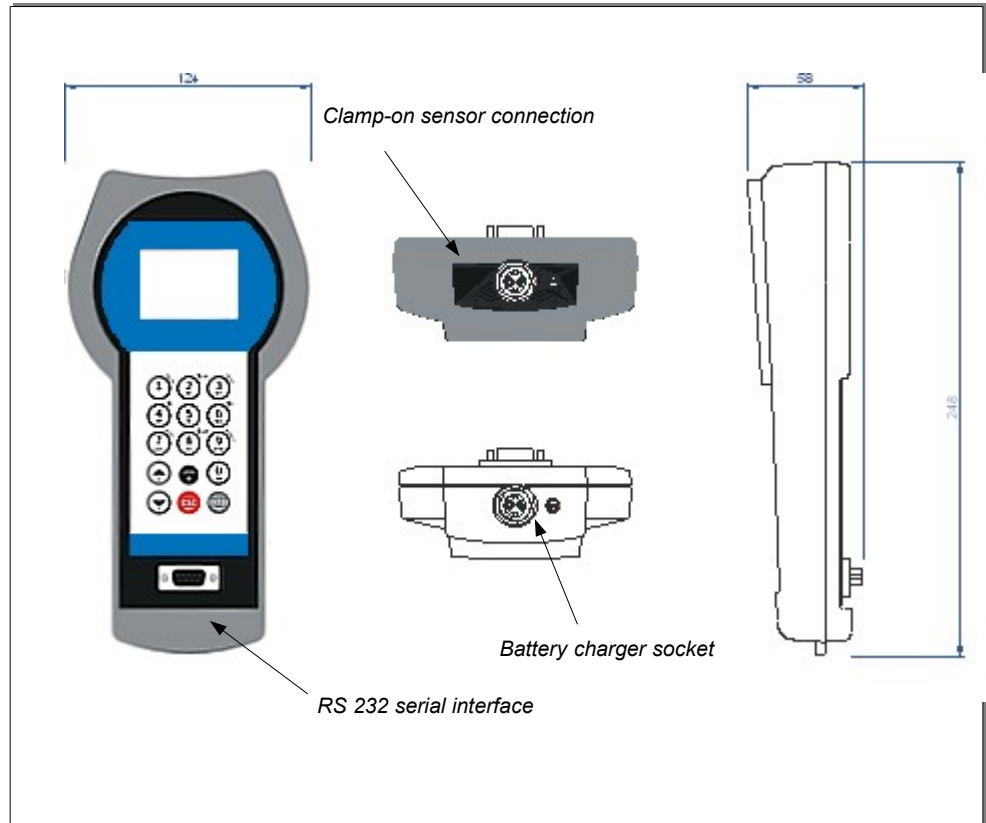

Drawing 1: Outline dimensions USCX200

K1 type transducer

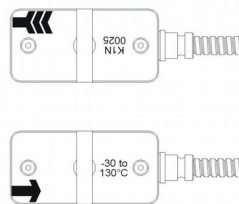

K4 type transducer

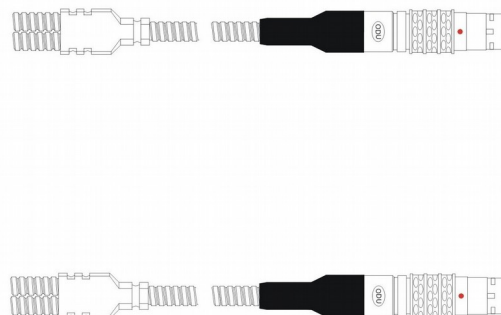
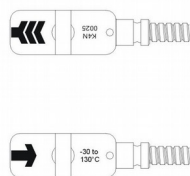

Drawing 2: Transducers

3.6.2 Electrical connections



3.7 Clamp-on sensor mounting

Before the sensors can be mounted

- the installation location should have been determined,
- a sensor mounting method should be chosen,
- the flowmeter batteries must be sufficiently charged,
- the sensors must be connected to the transmitter.

Depending on which sensor mounting method is being used, the clamp on sensors are either mounted on the same side of the pipe (Reflection Mode) or on opposite sides of the pipe (Diagonal Mode – See Section 2.5).

3.7.1 Sensor pipe mounting configurations

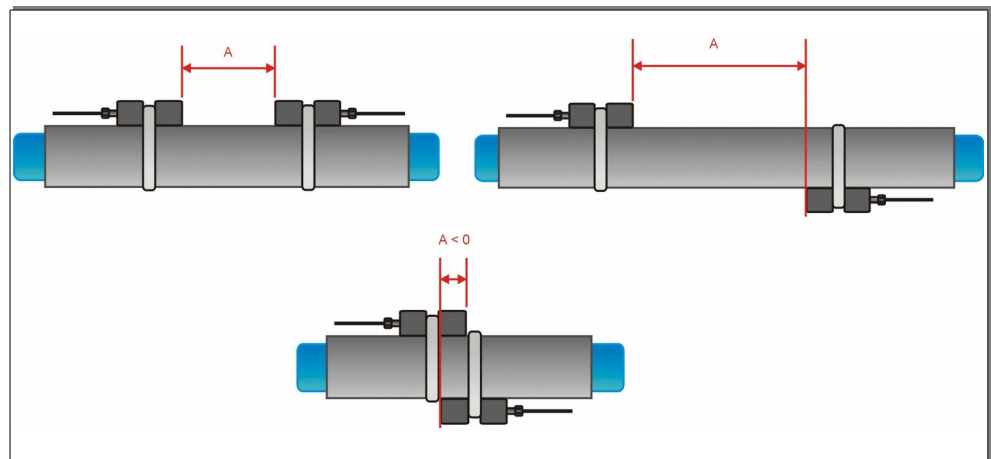

Illustration 4: Sensor pipe mounting configurations

3.7.2 Acoustic coupling gel

In order to obtain acoustical contact between the pipe and the sensors, apply a bead of acoustic coupling gel lengthwise down the centre of the contact area of the sensors.



Illustration 5: Application of acoustic coupling gel

3.7.3 Correct positioning of the sensors

Always mount the transducer pair so that the free front edges of the sensors face each other.

There is a different engraving on the top of each transducer. The transducers are mounted correctly if the engravings on the two transducers form an arrow. The transducer cables should point in opposite directions.



Later, the arrow, in conjunction with the indicated measured value, will help to determine the direction of flow.

The sensor separation distance is automatically calculated by the flowmeter based on the parameter entries for pipe outside diameter, wall thickness, lining material and thickness, medium, process temperature, the sensor type and the selected number of signal passes. The sensor positioning screen (above, and Section 3.3) allows fine adjustment of the sensor location.

3.7.4 Sensor mounting with fixtures and chains



Illustration 6: Sensor mounting with clips and chains

- Insert the retaining clip into the groove on the top of the transducer and secure it using the screw knob.
- Apply some acoustic coupling component to the contact surface of the transducer.
- Place the transducer on the side of the pipe or alternatively up to 45 degrees from the horizontal plane through the pipe. This is advisable to establish the best acoustic contact since on top of the pipe air pockets could develop and deposits could accumulate at the bottom of the pipe.
- Take the spring end of the chain in one hand and insert the last ball element in the vertical slot of the retaining clip. Mount the chain around the pipe.
- Pull the chain firmly around the pipe and fasten it in the lateral slot of the retaining clip. There should be no air pockets between the transducer surface and the pipe wall.
- Mount the second transducer the same way.
- Using a measuring tape, adjust the sensor separation distance as suggested by the flowmeter. When the sensor positioning screen (Section 3.3) is displayed, the middle bar allows fine adjustment of the sensor location.





Illustration 7: Sensor mounting with fixtures and chains (retaining clip)

4 Operation

4.1 Switching On/Off

The flowmeter is switched on by holding the **<ON>** key for more than 2 seconds continuously. Equally it can be switched off by pressing the **<OFF>** key for more than 2 seconds.

When switching on, the flowmeter will perform a hardware and software check, including the data logger space. Progress will be indicated by a series of dashes above and a black bar below.

4.2 Battery charging

The internal batteries can be recharged with the external battery charger supplied.



Important : *Ensure that only Nickel Metal Hydride (NiMH) AA size rechargeable batteries are installed – attempting to recharge other battery types is dangerous and may cause damage.*

Connect the battery charger to the charging socket of the flowmeter and to the mains supply 100 ... 240 VAC, 50/60 Hz. The battery charger mains plug is supplied for specific countries as shown in the order code.

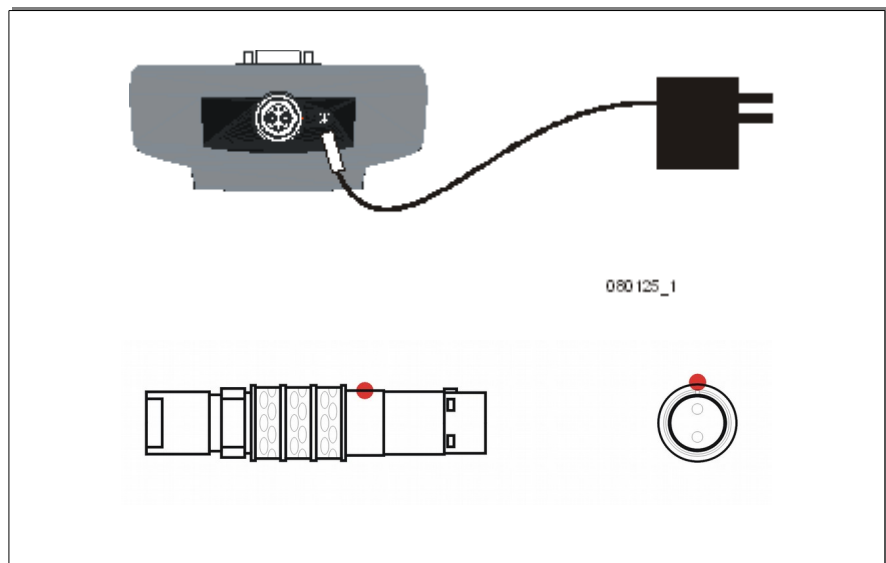

Illustration 8: Battery charging



The red mark on the plug aligns with the mark on the socket. Remove plug by sliding the outer casing away from the socket to release the latch.

During the charging process, the battery icon will blink. For a fully charged battery all segments of the battery icon will be filled.

Battery charge level is also shown in the diagnostic displays.

4.3 Keypad and display

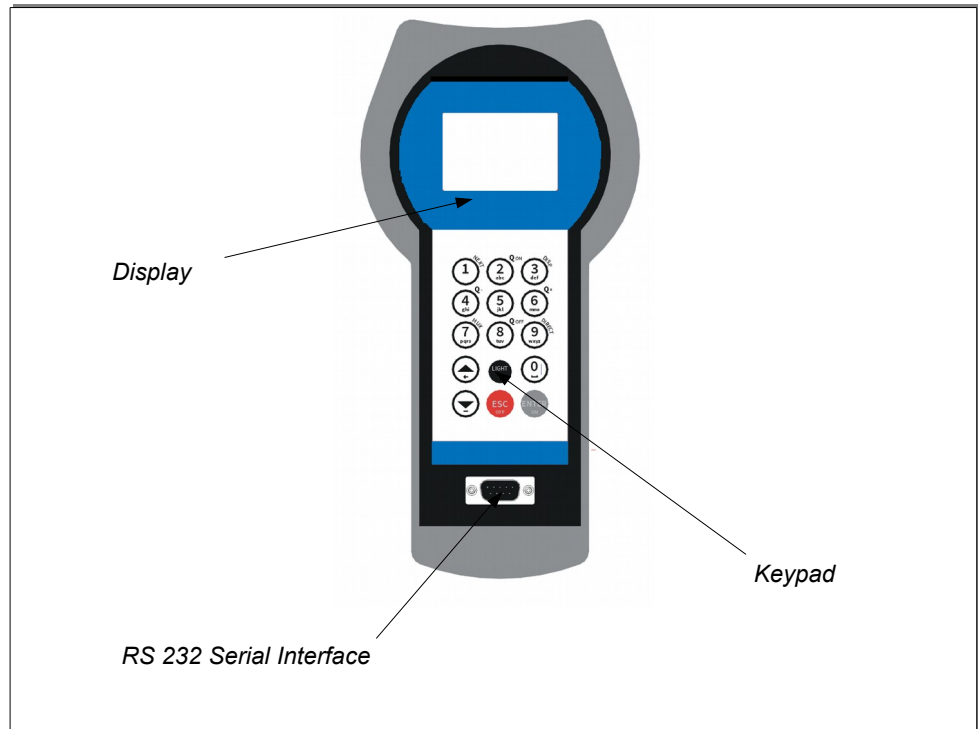













Illustration 9: Keypad and display overview









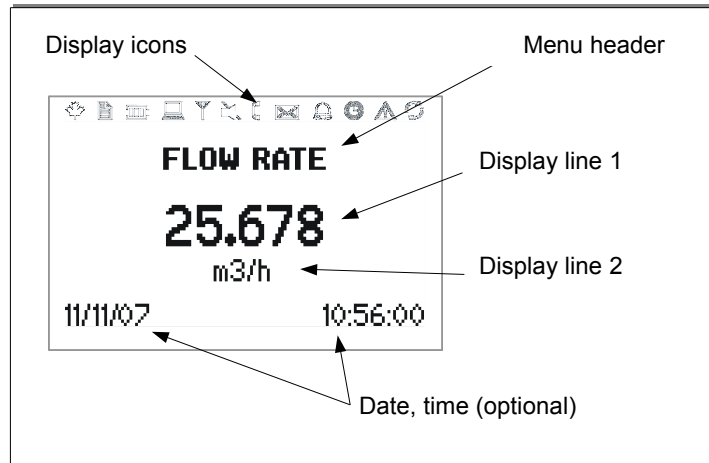

Keypad key functions



Key	Main function	Secondary function
	Character entry: 1 (1 short key stroke) , (2 short key strokes) . (3 short key strokes) _ (4 short key strokes)	Show NEXT available item
	Character entry: A B C 2 /	Q_{ON} = Start / reset totaliser function
	Character entry: D E F 3 ?	Show next DISP lay
	Character entry: G H I 4 <	Q- = Reset negative total value

	Character entry: J K L 5 >	
	Character entry: M N O 6 \$	Q+ = Reset positive total value
	Character entry: P Q R S 7	Toggle MU ltiple X er (where multi-channel functions are provided)
	Character entry: T U V 8 *	Q_{OFF} = Stop totaliser function
	Character entry: W X Y Z 9	DIRECT access to trend plot
	Move menu/list selection item UP	Character backspace clear
	Character entry: . (decimal point)	Switch LCD backlight on/off
	Character entry: 0 Space character + = #	
	Move menu/list selection item DOWN	Character entry : - (minus sign)
	ESC ape menu item	Abort entry without saving Switches the instrument OFF if pressed for more than 2 s
	ENTER menu item	Confirm entry with saving Switches the instrument ON if pressed for more than 2 s

4.3.1 Display functions







Display icon	Function
	On Icon not used Off Icon not used
	On Datalogger recording Off Datalogger switched off
	On 1 segment = 33% battery power available 2 segments = 66% battery power available 3 segments = 100% battery power available Off < 5% battery power available Outline blinking Battery charging
	On LCD backlight switched on Off LCD backlight switched off
	On Not used on KF200 Off Not used on KF200
	On Speaker on Off Speaker off
	On Coupling error Off Sensor operating correctly
	On Icon not used Off Icon not used
	On Icon not used Off Icon not used
	On Time/date set Off Clock error

	On Error recorded in error log Off No error detected
	On Serial output RS 232 switched on Off Serial output RS 232 switched off
"L", "LT" or "T"	Displays whether flow is laminar, turbulent or mixed

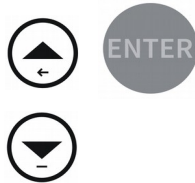
4.4 Quick setup wizard

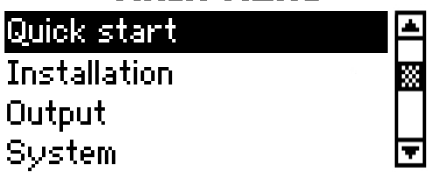
The quick setup wizard allows for a speedy setup of the most important parameters in order to achieve successful measurements in the shortest possible time:

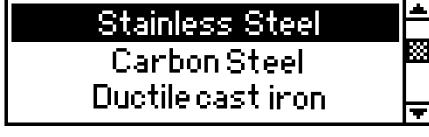

Display screen	Operation
<p>MAIN MENU</p> 	<p>The main menu is displayed after first power on and the boot-up sequence.</p> <p>Use <UP> and <DOWN> cursor keys to select Quick start. Confirm by pressing <ENTER>.</p>
<p>QUICK START</p> 	<p>Use cursor keys to select Setup Wizard. Confirm by pressing <ENTER>.</p> <p>If sensors are recognised, the serial number will be shown. If not recognised or not connected, they may be selected from a list.</p>
<p>MIDDLE UNITS</p> 	<p>Select units of measurement using cursor keys and pressing <ENTER>.</p>
<p>PIPE MATERIAL</p> 	<p>Choose pipe material using cursor keys and pressing <ENTER>.</p>
<p>OUTSIDE DIAMETER</p> 	<p>Enter outside pipe diameter using alphanumeric keys and confirm by pressing <ENTER>.</p> <p>Use key <UP> as character backspace clear to correct for data entry errors.</p>



<p>WALL THICKNESS</p> <p style="text-align: center;">3.4 mm</p>	<p>Enter pipe wall thickness using alphanumerical keys and confirm by pressing <ENTER>.</p> <p>Use key <UP> as character backspace clear to correct for data entry errors.</p>
<p>FLUID</p> <div style="border: 1px solid black; padding: 5px;"> <p style="background-color: black; color: white; padding: 2px;">Water</p> <p>Saltwater</p> <p>Acetone</p> </div>	<p>Select fluid using cursor keys.</p> <p>Confirm by pressing <ENTER>.</p>
<p>TEMPERATURE</p> <p style="text-align: center;">20.0 C</p>	<p>Enter process temperature using alphanumerical keys and confirm by pressing <ENTER>.</p> <p>Use key <UP> as character backspace clear to correct for data entry errors.</p>
<p>LINER MATERIAL</p> <div style="border: 1px solid black; padding: 5px;"> <p style="background-color: black; color: white; padding: 2px;">None</p> <p>Epoxy</p> <p>Rubber</p> </div>	<p>Select pipe lining material using cursor keys.</p> <p>Confirm by pressing <ENTER>.</p>
<p>PASSES</p> <div style="border: 1px solid black; padding: 5px;"> <p style="background-color: black; color: white; padding: 2px;">Auto</p> <p>1</p> <p>2</p> </div>	<p>Select transducer configuration (number of passes) using cursor keys.</p> <p>Auto Automatically</p> <p>1 1 pass, diagonal mode</p> <p>2 2 passes, reflection mode</p> <p>3 3 passes, diagonal mode</p> <p>4 4 passes, reflection mode</p> <p>5 5 passes, diagonal mode</p> <p>6 6 passes, reflection mode</p> <p>..etc.</p> <p>Confirm by pressing <ENTER>.</p>
<p>QUICK START</p> <div style="border: 1px solid black; padding: 5px;"> <p>Setup Wizard</p> <p>Stored Setup</p> <p style="background-color: black; color: white; padding: 2px;">Start Measurement</p> </div>	<p>Use cursor keys to select Start Measurement. Confirm by pressing <ENTER>.</p>

<p style="text-align: center;">CHNL1 SENSOR</p> <p>Spacing 110.5 mm Using 2 passes Signal 26 dB</p> 	<p>Sensor placement screen: Mount transducers with suggested spacing and use middle bar for fine adjustment of position (central position is desired). Observe signal-to-noise (upper bar) and quality (lower bar). These should be of identical length.</p> <p>Confirm by pressing <ENTER> to obtain measurements.</p> <p>Note : Numbers shown are for indication only.</p>
<p style="text-align: center;">CHNL-1</p> <p style="text-align: center;">25.678 m3/h</p> <p>11/11/07 10:56:00</p>	<p>Success!</p>

4.5 Measurements

4.5.1 Main process value (PV) display

Measurements are started using **Start Measurement** in the Quick Start Wizard.



Display screen	Operation
<p style="text-align: center;">FLOW RATE</p> <p style="text-align: center;">25.678 m3/h</p> <p>11/11/07 10:56:00</p>	<p>The main process value can be changed in the “Quick Start” or “Installation” menus.</p> <p>Press <ESC> at any time to return to the main menu.</p> <p>View totalizers by pressing <NEXT>.</p> <p>Change to the Diagnostic display by pressing <DISP>.</p>

3-line display format



Display screen	Operation
<p style="text-align: center;">CHNL-1</p> <p style="text-align: center;">- 0.0 m3 25.678 m3/h 1.370 m/s</p> <p>11/11/07 10:56:00</p>	<p>The three-line display screen is configurable to show flow, totalizers and diagnostic functions.</p> <p>Change to diagnostic displays by pressing <DISP> and to totalizer screens by pressing <NEXT>.</p> <p>Cycle through display screens using <NEXT>.</p>

4.5.2 Diagnostic displays



Display screen	Operation
<p>DIAGNOSTIC 1</p> <p>55.2 Gain</p> <p>20.5 Signal</p> <p>-10.0 Noise</p> <p>11/11/07 10:56:00</p>	<p>Line 1 shows the amplifier gain.</p> <p>Line 2 displays the signal strength.</p> <p>Line 3 indicates the noise.</p> <p>Change to more diagnostic displays by pressing <NEXT>.</p> <p>Refer to Customer Support for the meanings of each diagnostic screen</p>

4.5.3 Totalisers

The totaliser displays will only be shown when the totalisers are activated.

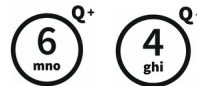

Display screen	Operation
<p>TOTALISER -1</p> <p>- 0.0 m3</p> <p>0.0 +</p> <p>- 0.0 -</p> <p>11/11/07 10:56:00</p>	<p>The flow totaliser can be started or reset by pressing <Q_{ON}> when a volume measurement is selected as one of the displayed units.</p> <p>Totalizer screens are viewed by pressing <NEXT> from the measurement screen. When top and bottom display lines are set to a volume measurement, the first totalizer screen displays cumulative totals and the second screen shows separate positive and negative totals. Pressing <NEXT> again will return to the main measurement screen.</p> <p>Pressing <Q₊> resets the total accumulated flow in the positive flow direction. Pressing <Q₋> resets the total accumulated flow in the negative flow direction.</p> <p>The totalisers can be stopped by pressing <Q_{OFF}>.</p> <p>Pressing <Q_{ON}> again will reset to zero. Change to other displays or revert to the totalizer screen without resetting by pressing <DISP> or <NEXT>.</p>

4.5.4 Datalogger



The datalogger is enabled from the Main Menu, and operates when a non-zero value is entered for the interval.

Items to be logged are selected from the "Selection" screen. "ENTER" selects items, "0" deselects. Up to ten items may be selected.

(Note : If no items are selected the logger will record blank space)

Send logger by serial port to a terminal program by selecting "Log download".

Clear the logger by selecting "Log Erase".

Remaining logger space can be seen in the Diagnostic displays.

Logged data can be downloaded, viewed and exported using the Data+ software except when "wrap" mode has been enabled.

5 Commissioning

5.1 Menu structure

Main menu	Menu level 1	Menu level 2	Description/settings
Quick Start			
	Setup Wizard		
		Sensor type	<i>Indication of sensor type and serial number if automatically detected, otherwise select from list</i> ↑↓ K1N,K1L,K1E,K1Ex,K1P, K4N,K4L,K4E,K4Ex,K4P, K0, M, Q, Special
		Middle (main displayed) Units	<i>Select from list where available</i> ↑↓ m/s, f/s, in/s, m ³ /h, m ³ /min, m ³ /s, l/h, l/min, l/s, USgal/h, USgal/min, USgal/s, bbl/d, bbl/h, bbl/min, g/s, t/h, kg/h, kg/min, m ³ , l, USgal, bbl, g, t, kg, W, kW, MW, J, kJ, MJ, Signal dB, noise dB, SNR (dB), C m/s (sound speed), CU (housing temperature), K (correction factor), REY (Reynolds number), SOS, DEN, KIN, SHC (sound speed, density, kinematic viscosity, Specific Heat Capacity from inputs/calculation), TEMP (specified or measured fluid temperature), PRESS (specified or measured fluid pressure), Tin, Tout (inlet and outlet temperature) Other (Assignable input or calculated value), Math (Calculated value – see below).
		Pipe material	<i>Select from list</i> ↑↓ Stainless steel, Carbon steel, Ductile cast iron, Grey cast iron, Copper, Lead, PVC, PP, PE, ABS, Glass, Cement, User (pipe c-speed)
		Pipe c-speed	<i>Only if user pipe material selected</i> 500 ... 5000 m/s
		Outside diameter	10 ... 3000 mm
		Wall thickness	0.5 ... 75 mm
		Fluid	<i>Select from list</i> ↑↓ Water, Salt water, Acetone, Alcohol, Ammonia Carbon Tet (carbon tetrachloride), Ethanol, Ethyl alcohol, Ethyl ether, Ethylene glycol, Glycol/water 50%, Kerosene, Methanol, Methyl alcohol Milk, Naphtha, Car oil, Freon R134a, Freon R22 Hydrochloric acid, Sour cream, Sulphuric acid Toluene, Vinyl chloride User (kinematic viscosity, density, medium c- speed)
		Kinematic viscosity	<i>Only if user fluid selected</i> 0 ... 30000 mm ² /s
		Density	<i>Only if user fluid selected</i> 100 ... 2000 kg/m ³
		Medium c-speed	<i>Only if user fluid selected</i> 800 ... 3500 m/s
		Temperature	-30 ... 300 °C
		Liner Material	<i>Select from list</i> ↑↓ None, Epoxy, Rubber, PVDF, PP, Glass, Cement, User (liner c-speed)
		Liner c-speed	<i>Only if lining material selected</i> 500 ... 5000 m/s
		Liner thickness	<i>Only if lining material selected</i> 1.0 ... 99.0 mm

		Passes	Select from list ↑↓ Auto, 1...16
	Stored Setup		Load, Save or Delete stored sets of parameters. (Names for different measurement points can be entered on "Save" using the keypad)
	Start Measurement		
		Sensor type	Indication of sensor type and serial number if automatically detected, otherwise select from list ↑↓ (see above)
		SP 1 - Sensor frequency	Only for special, unrecognised sensors 5 ... 80
		SP 2 - Wedge angle	Only for special, unrecognised sensors
		SP3 – Wedge c-speed	Only for special, unrecognised sensors
		SP4 - Crystal offset	Only for special, unrecognised sensors
		SP5 - Spacing offset	Only for special, unrecognised sensors
		SP6 - Zero flow offset	Only for special, unrecognised sensors
		SP7 - Up-stream offset	Only for special, unrecognised sensors
	Sensor placement		
Installation			
	Pipe		
		Material	Select from pipe material list
		Outside diameter	6 ... 6500 mm
		Wall thickness	0.5 ... 75 mm
		Pipe c-speed	600 ... 6554 m/s (transverse sound speed)
		Pipe l-speed	600 ... 8000 m/s (longitudinal sound speed)
		Pipe circumference	18.8 ... 20420 mm
		Roughness	0.0 ... 10 mm
	Medium		
		Fluid	Select from fluid list
		Kinematic viscosity	0 ... 30000 mm ² /s
		Density	100 ... 2000 kg/m ³
		C-speed	800 ... 3500 m/s
		Temperature	-30 ... 300 °C
	Lining		
		Material	Select from material list
		Thickness	0.1 ... 99.9 mm
		C-speed	500 ... 5000 m/s
	Passes		Select from list

Output			
	Display		
		Top Line	<i>Units (Select from list ↑↓)</i>
		Middle Line	<i>Units (Select from list ↑↓)</i>
		Bottom Line	<i>Units (Select from list ↑↓)</i>
		Damping	<i>Reduces fluctuations in the display output. 1 ... 255 s</i>
	Datalogger		
		Interval	0 ... 999 s
		Selection	From list. <ENTER> selects, <0> deselects. Up to ten variables may be logged.
		Low memory	<i>Warning output 0 ... 100 %</i>
		Log Wrap	<i>Saves "selected" items as a continuous stream without headers (Note : this means files cannot be processed by Data+) Yes/No</i>
		Log download	<i>Sends all log data using RS232 serial port</i>
		Log erase	<i>Clears the logger</i>
	Serial communica- tion		
		Mode	<i>Select from list ↑↓ None Printer (output every second of selected values) Diagnostic Download (send logger data using RS232) Cal Test (laboratory calibration, not recommen- ded for field or customer use)</i>
		Baud	<i>Select from list ↑↓ 9600 (Default) 19200, 57600, 115200</i>
		Parity	<i>Select from list ↑↓ None Even (Default) Odd</i>
System			
	Instrument info		
		Model code	KF200
		Serial number	<i>Example: 20000003</i>
		HW revision	<i>Example: 2.0, 1.5</i>
		SW revision	<i>Example: 3.2, 3.1</i>
	Calculation		
		Low flow cut off	0 ... 0.10 m/s
		Max. flow cut off	0 ... 30 m/s
		Corrected	Yes (flow profile correction) No
		PV offset	-30 ... 30 units
		PV scaling	0 ... 1000 units
		Zero calibration	Adjust : Zero (Yes/No) : Sets current flow as zero Track (Yes/No) : Zero follows output variations Delta time : Zero flow offset in ns Time up : Upstream offset in ns

	User		
		Identifier	<i>Example:</i> Pump P3A
		Tag number	<i>Example:</i> 1FT-3011
	Test		
		Test Modes	Tests integrity of device and features. "Installation" simulates a rising flow rate.
	Settings		
		Date	<i>Example:</i> 03/10/2007
		Time	<i>Example:</i> 09:27:00
		Date format	Select from list ↑↓ dd/mm/yy mm/dd/yy yy/mm/dd
		Language	Select from list ↑↓(as available) English, German, French, Spanish, Russian
		Keypad sound	Yes No
		Battery	Low warning : Yes / No Auto off timer 1 ... 59 min
	Defaults (Load defaults)		Yes No
Diagnostics			
			Shows measured temperature, available logger memory, battery charge level, battery voltage (Cycle using <ENTER>)
Scope			
			Displays the received acoustic pulse (see 5.7)

5.2 Diagnostics

Diagnostic screens can be viewed directly during measurement or through the menu structure.

5.3 Display settings

Customer specific settings for data to be displayed can be achieved by using the appropriate menu items.

5.3.1 Main PV

The main Process Value (PV) is the primary measurement data.

5.4 Output settings

5.4.1 Serial interface RS 232

The RS 232 serial interface can be used to transmit data on-line or to download the integral datalogger content. The settings can be found in the **Serial Communication** submenu .

5.5 Data+ software

Software can be provided for downloading the contents of the datalogger and communication with the flowmeter.

5.6 Wall thickness measurement (WTM)

Optional sensor probes to measure pipe wall thickness are available. The KF200 will recognise a connected probe when entering the Setup or WTM Wizards, the measurement mode or the Scope function. Use the Setup Wizard or Installation menu to set the pipe material. Select "Start Measurement". The KF200 will recognise the probe and display the measurement screen. Wall thickness will be shown when the sensor is in good acoustic contact with the pipe.

5.6.1 Wall Thickness Gauge (WTG) Wizard

To confirm pipe thickness and sound speed, select the "WTG Wizard" from the "Quick Start" menu. Enter the approximate expected thickness as "Reference THK" and select "Calibrate".

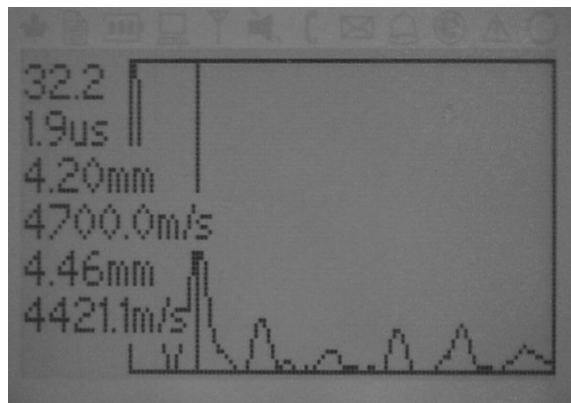

The screen displays the received acoustic pulse and values for the signal strength, the transit time, the reference thickness, the expected sound speed, the measured thickness at the reference sound speed and the measured sound speed at the reference thickness (top to bottom).

On leaving this screen using the <ESC> key, the flowmeter will ask if you wish to store the recorded value of longitudinal sound speed ("L-Speed" in the Pipe Menu).

5.7 Scope function

USCX series flowmeters have an additional scope function which shows a representation of the pulse received by the sensors.

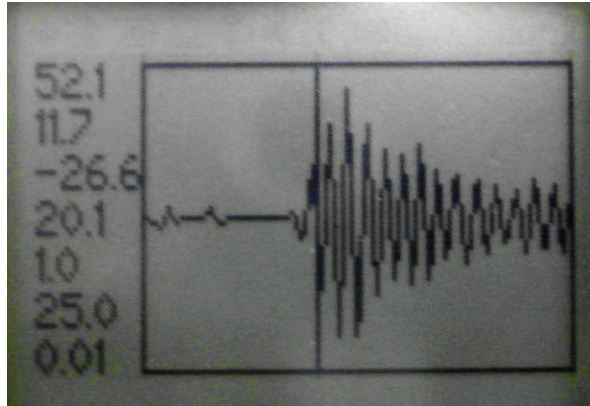

In addition to displaying the received pulse, this screen lists the following data (from top to bottom) :

Gain (dB)
Signal (dB)
Noise (dB)
Transit time (us)
Delta (ns) - [time downstream minus time upstream]
Control unit temperature (degC)
Flow (m/s)

6 Maintenance

USCX series flowmeters are maintenance free concerning the flow measurement functions. Within the scope of periodic inspections, regular inspection for signs of damage or corrosion is recommended for the transducers, the junction box if installed, and the flowmeter housing.

6.1 Service/Repair

USCX series flowmeters have been carefully manufactured and tested. If installed and operated in accordance with the operating instructions, no problems are usually experienced.

Should you nevertheless need to return a device for inspection or repair, please pay attention to the following points:



- Due to statutory regulations on environmental protection and safeguarding the health and safety of our personnel, the manufacturer may only handle, test and repair returned devices that have been in contact with products without risk to personnel and environment.
- This means that the manufacturer can only service this device if it is accompanied by a Customer Return Note (CRN) confirming that the device is safe to handle.

If the device has been operated with toxic, caustic, flammable or water-endangering products, you are kindly requested:



- to check and ensure, if necessary by rinsing or neutralising, that all cavities are free from such dangerous substances,
- to enclose a certificate with the device confirming that is safe to handle and stating the product used.

7 Troubleshooting

Most problems with measurement are due to poor signal strength or quality. Initial checks should include :



- Has sufficient acoustic coupling paste been applied?
- Can the number of sound passes be changed? As a general rule, more passes will improve accuracy, fewer passes will give better signal strength.
- Are there any nearby sources of noise or disturbance?
- Can the signal be improved by moving the sensors around the circumference of the pipe?
- Are the application parameters correct?

Should there be the need to call customer service, please let us know the following details:

- Model code
- Serial number
- SW, HW revision
- Error log list

Possible error messages may include the following:

Error list

Error message	Group	Description	Error handling
USB INIT FAIL	Hardware	Internal board communication error	Power on/off, otherwise call customer support
NO SERIAL NO.	Hardware	Failed to read from FRAM	Call customer support
NO VERSION NO.	Hardware	Failed to read from FRAM	Call customer support
PARA READ FAIL	Hardware	Failed to read from FRAM	Load defaults, otherwise call customer support
PARA WRITE FAIL	Hardware	Failed to write to FRAM	Load defaults, otherwise call customer support
VAR READ FAIL	Hardware	Failed to read from FRAM	Call customer support
VAR WRITE FAIL	Hardware	Failed to write to FRAM	Call customer support
SYSTEM ERROR	Hardware		Call customer support
VISIBILITY ERR	Hardware	Failed to read from FRAM	Call customer support
FRAM LONG WRITE ERR	Hardware	Failed to write to FRAM	Call customer support
FRAM READ ERR	Hardware	Failed to read from FRAM	Call customer support
RTC ERR	Hardware	Real Time Clock failure	Power on/off, otherwise call customer support
EXTMEM ERR	Hardware	Logger memory failure	Power on/off, otherwise call customer support
SPI ERR	Hardware	SPI bus failure	Power on/off, otherwise call customer support
I2C ERR	Hardware	I2C bus failure	Power on/off, otherwise call customer support
MATH ERR	Software	Internal calculation error	Call customer support
STACK ERR	Software	Internal calculation error	Call customer support
ADDR ERR	Software	Internal calculation error	Call customer support
OSC ERR	Software	Internal calculation error	Call customer support
ADC ERR	Software	Internal calculation error	Call customer support

...continued

Error message	Group	Description	Error handling
IO ERR	Software	Internal calculation error	Call customer support
TIMING ERR	Software	Internal calculation error	Call customer support
COMM INIT ERR	Hardware	Internal communication error	Power on/off, otherwise call customer support
COMM START ERR	Hardware	Internal communication error	Power on/off, otherwise call customer support
COMM HS0 ERR	Hardware	Internal communication error	Power on/off, otherwise call customer support
COMM HS1 ERR	Hardware	Internal communication error	Power on/off, otherwise call customer support
COMM READ AVE ERR	Hardware	Internal communication error	Power on/off, otherwise call customer support
COMM READ RAW ERR	Hardware	Internal communication error	Power on/off, otherwise call customer support
COMM READ HISTORY ERR	Hardware	Internal communication error	Power on/off, otherwise call customer support
COMM CRC ERR	Hardware	Internal communication error	Power on/off, otherwise call customer support
SENSOR COUPLING ERR	Application	Weak sensor coupling, low SNR	Recouple sensors, check installation, reduce number of passes, look for other location, otherwise call customer support

Table 3: Error messages

7.1 Data download difficulties

If difficulties are encountered downloading the logger data : -

- Check that the flowmeter is switched on and not in measurement mode.
- Check that the same number COM port is allocated in the "Device Manager" (or equivalent) as is set in the Data+ software.
- Check that the settings (baud, parity, word length, stop bits) are identical.
- Use the supplied connectors – whether connecting to a 9-pin COM port or converting from serial communication to a Universal Serial Bus (USB).
- Is the logger in "Wrap" mode? If "yes", use a terminal program and the "Log download" command. If "No", Data+ software may also be used.

8 Technical data

Material	Sound Speed* Shear Wave (at 25 °C)	
	m/s	ft/s
Steel, 1% Carbon, hardened	3,150	10,335
Carbon Steel	3,230	10,598
Mild Steel	3,235	10,614
Steel, 1% Carbon	3,220	10,565
302 Stainless Steel	3,120	10,236
303 Stainless Steel	3,120	10,236
304 Stainless Steel	3,141	10,306
304L Stainless Steel	3,070	10,073
316 Stainless Steel	3,272	10,735
347 Stainless Steel	3,095	10,512
"Duplex" stainless steel	2,791	9,479
Aluminium	3,100	10,171
Aluminium (rolled)	3,040	9,974
Copper	2,260	7,415
Copper (annealed)	2,325	7,628
Copper (rolled)	2,270	7,448
CuNi (70%Cu 30%Ni)	2,540	8,334
CuNi (90%Cu 10%Ni)	2,060	6,759
Brass (Naval)	2,120	6,923
Gold (hard-drawn)	1,200	3,937
Inconel	3,020	9,909
Iron (electrolytic)	3,240	10,630
Iron (Armco)	3,240	10,630
Ductile Iron	3,000	9,843
Cast Iron	2,500	8,203
Monel	2,720	8,924
Nickel	2,960	9,712
Tin (rolled)	1,670	5,479
Titanium	3,125	10,253
Tungsten (annealed)	2,890	9,482
Tungsten (drawn)	2,640	8,661
Tungsten carbide	3,980	13,058
Zinc (rolled)	2,440	8,005
Glass (pyrex)	3,280	10,761
Glass (heavy silicate flint)	2,380	7,808
Glass (light borate crown)	2,840	9,318
Nylon	1,150	3,772
Nylon, 6-6	1,070	3,510
Polyethylene (LD)	540	1,772
PVC, CPVC	1,060	3,477
Acrylic resin	1,430	4,690
PTFE	2,200	7,218

* Please note these values are to be considered nominal. Solids may be inhomogeneous and anisotropic. Actual values depend on exact composition, temperature, and to a lesser extent, on pressure and stress.

All data given at 25 °C (77 °F) unless otherwise stated

Substance	Chemical Formula	Specific Gravity	Sound Speed		Change v/°C	Viscosity (Kinematic)	
			m/s	ft/s		mm ² /s	x10-6 ft ² /s
Acetic anhydride	(CH ₃ CO) ₂ O	1.082 (20 °C)	1,180	3,871.4	2.5	0.769	8.274
Acetic acid, anhydride	(CH ₃ CO) ₂ O	1.082 (20 °C)	1,180	3,871.4	2.5	0.769	8.274
Acetic acid, nitrile	C ₂ H ₃ N	0.783	1,290	4,232.3	4.1	0.441	4.745
Acetic acid, ethyl ester	C ₄ H ₈ O ₂	0.901	1,085	3,559.7	4.4	0.467	5.025
Acetic acid, methyl ester	C ₃ H ₆ O ₂	0.934	1,211	3,973.1		0.407	4.379
Acetone	C ₃ H ₆ O	0.791	1,174	3,851.7	4.5	0.399	4.293
Acetylene dichloride	C ₂ H ₂ Cl ₂	1.26	1,015	3,330.1	3.8	0.400	4.304
Acetylene tetrachloride	C ₂ H ₂ Cl ₄	1.595	1,147	3,763.1		1.156 (15°C)	12.44 (15°C)
Alcohol	C ₂ H ₆ O	0.789	1,207	3,960.0	4.0	1.396	15.02
Ammonia	NH ₃	0.771	1,729 (33 °C)	(- 5,672.6 (-27 °C))	6.68	0.292 (-33 °C)	3.141 (-27 °F)
Benzene	C ₆ H ₆	0.879	1,306	4,284.8	4.65	0.711	7.65
Benzol	C ₆ H ₆	0.879	1,306	4,284.8	4.65	0.711	7.65
Bromine	Br ₂	2.928	889	2,916.7	3.0	0.323	3.475
n-Butane(2)	C ₄ H ₁₀	0.601 (0°C)	1,085 (5° C)	(- 3,559.7 (23 °C))	5.8		
2-Butanol	C ₄ H ₁₀ O	0.81	1,240	4,068.2	3.3	3.239	34.851
sec-Butylalcohol	C ₄ H ₁₀ O	0.81	1,240	4,068.2	3.3	3.239	34.851
n-Butyl bromide (46)	C ₄ H ₉ Br	1.276 (20°C)	1,019 (20°C)	3,343.2 (68°F)		0.49 (15°C)	5.272 (59°C)
n-Butyl chloride (22,46)	C ₄ H ₉ Cl	0.887	1,140	3,740.2	4.57	0.529 (15°C)	5.692 (59°F)
Carbon tetrachloride	CCl ₄	1.595 (20°C)	926	3038.1	2.48	0.607	6.531
Carbon tetrafluoride (Freon 14)	CF ₄	1.75 (-150 °C)	875.2 (150 °C)	(- 2,871.5 (-238 °F))	6.61		
Chloroform	CHCl ₃	1.489	979	3,211.9	3.4	0.55	5.918
Dichlorodifluoromethane (Freon 12)	CCl ₂ F ₂	1.516 (40 °C)	774.1	2,539.7	4.24		
Ethanol	C ₂ H ₆ O	0.789	1,207	3,960	4.0	1.39	14.956
Ethyl acetate	C ₄ H ₈ O ₂	0.901	1,085	3,559.7	4.4	0.489	5.263
Ethyl alcohol	C ₂ H ₆ O	0.789	1,207	3,960	4.0	1.396	15.020
Ethyl benzene	C ₈ H ₁₀	0.867 (20 °C)	1,338 (20 °C)	4,89.8 (68 °F)		0.797 (17 °C)	8.575 (63 °F)
Ether	C ₄ H ₁₀ O	0.713	985	3231.6	4.87	0.311	3.346
Ethyl ether	C ₄ H ₁₀ O	0.713	985	3231.6	4.87	0.311	3.346
Ethylene bromide	C ₂ H ₄ Br ₂	2.18	995	3264.4		0.79	8.5
Ethylene chloride	C ₂ H ₄ Cl ₂	1.253	1,193	3,914		0.61	6.563
Ethylene glycol	C ₂ H ₆ O ₂	1.113	1,658	5439.6	2.1	17,208 (20°C)	185.158 (68°F)
Fluorine	F	0.545 (-143 °C)	403 (- 143 °C)	(- 1322.2 (- 225 °F))	11.31		
Formaldehyde, methyl ester	C ₂ H ₄ O ₂	0.974	1,127	3697.5	4.02		
Freon R12			774.2	2540			
Glycol	C ₂ H ₆ O ₂	1.113	1658	5439.6	2.1		
50% Glycol/50% H ₂ O			1,578	5,177			
Isopropanol	C ₃ H ₈ O	0.785 (20 °C)	1,170 (20 °C)	3,838.6 (68 °F)		2.718	29.245
Isopropyl alcohol (46)	C ₃ H ₈ O	0.785 (20 °C)	1,170 (20 °C)	3,838.6 (68 °F)		2.718	29.245

Kerosene		0.81	1,324	4,343.8	3.6		
Methane	CH ₄	0.162 (-89 °C)	405 (-89 °C)	1,328.7 (-128 °F)	17.5		
Methanol	CH ₄ O	0.791 (20 °C)	1,076	3,530.2	292	0.695	7.478
Methyl acetate	C ₃ H ₆ O ₂	0.934	1,211	3,973.1		0.407	4.379
Methyl alcohol	CH ₄ O	0.791	1,076	3,530.2	292	0.695	7.478
Methyl benzene	C ₇ H ₈	0.867	1,328 (20 °C)	4,357 (68 °F)	4.27	0.644	7.144
Milk, homogenized			1,548	5,080			
Naphtha		0.76	1,225	4,019			
Natural Gas		0.316 (-103 °C)	753 (-103 °C)	2,470.5 (-153 °F)			
Nitrogen	N ₂	0.808 (-199 °C)	962 (-199 °C)	3,156.2 (-326 °F)		0.217 (-199 °C)	2.334 (-326 °F)
Oil, Car (SAE 20a.30)		1.74	870	2,854.3		190	2,045.093
Oil, Castor	C ₁₁ H ₁₀ O ₀	0.969	1,477	4,845.8	3.6	0.670	7.209
Oil, Diesel		0.80	1,250	4,101			
Oil, Fuel AA gravity		0.99	1,485	4,872	3.7		
Oil (Lubricating X200)			1,530	5,019.9			
Oil (Olive)		0.912	1,431	4,694.9	2.75	100	1,076.365
Oil (Peanut)		0.936	1,458	4,738.5			
Propane (-45 to -130 °C)	C ₃ H ₈	0.585 (-45 °C)	1,003 (45 °C)	3,290.6 (-49 °F)	5.7		
1-Propanol	C ₃ H ₈ O	0.78 (20 °C)	1,222 (20 °C)	4,009.2 (68 °F)			
2-Propanol	C ₃ H ₈ O	0.785 (20 °C)	1,170 (20 °C)	3,838.6 (68 °F)		2.718	29.245
Propene	C ₃ H ₆	0.563 (-13 °C)	963 (13 °C)	3,159.4 (9 °F)	6.32		
n-Propyl-alcohol	C ₃ H ₈ O	0.78 (20 °C)	1,222 (20 °C)	4,009.2 (68 °F)		2.549	27.427
Propylene	C ₃ H ₆	0.563 (-13 °C)	963 (-13 °C)	3,159.4 (9 °F)	6.32		
Refrigerant 11	CCl ₃ F	1.49	828.3 (0 °C)	2,717.5 (32 °F)	3.56		
Refrigerant 12	CCl ₂ F ₂	1.516 (-40 °C)	774.1 (40 °C)	2,539.7 (-40 °C)	4.24		
Refrigerant 14	CF ₄	1.75 (-150 °C)	875.24 (150 °C)	2,871.6 (-268 °F)	6.61		
Refrigerant 21	CHCl ₂ F	1.426 (0 °C)	891 (0 °C)	2,923.2 (32 °F)	3.97		
Refrigerant 22	CHClF ₂	1.491 (-69 °C)	893.9 (50 °C)	2,932.7 (122 °F)	4.79		
Refrigerant 113	CCl ₂ F-CClF ₂	1.563	783.7 (0 °C)	2,571.2 (32 °F)	3.44		
Refrigerant 114	CClF ₂ -CClF ₂	1.455	665.3 (10 °C)	2,182.7 (14 °F)	3.73		
Refrigerant 115	C ₂ ClF ₅		656.4 (50 °C)	2,153.5 (-58 °F)	4.42		
Refrigerant C318	C ₄ F ₈	1.62 (-20 °C)	574 (-10 °C)	1,883.2 (14 °F)	3.88		
Sodium nitrate	NaNO ₃	1.884 (336 °C)	1,763.3 (336 °C)	5,785.1 (637 °F)	0.74	1.37 (336 °C)	14.74 (637 °F)
Sodium nitrite	NaNO ₂	1.805 (292 °C)	1,876.8 (292 °C)	6,157.5 (558 °F)			
Sulphur	S		1,177 (250 °C)	3,861.5 (482 °F)	-1.13		
Sulphuric Acid	H ₂ SO ₄	1.841	1,257.6	4,126	1.43	11.16	120.081

Tetrachloroethane	C2H2Cl4	1553 (20 °C)	1,170 (20 °C)	3,838.6 (68 °F)		1.19	12.804
Tetrachloroethene	C2Cl4	1.632	1,036	3,399			
Tetrachloromethane	CCl4	1.595 (20 °C)	926	3,038.1		0.607	6.531
Tetrafluoromethane (Freon 14)	CF4	1.75 (-150 °C)	875.24 (- 150 °C)	2,871.5 (-283 °F)	6.61		
Toluene	C7H8	0.867 (20 °C)	1,328 (20 °C)	4,357 (68 °F)	4.27	0.644	6.929
Toluol	C7H8	0.866	1,308	4,291.3	4.2	0.58	6.24
Trichlorofluoromethane (Freon 11)	CCl3F	1.49	828.3 (0 °C)	2,717.5 (32 °F)	3.56		
Turpentine		0.88	1,255	4,117.5		1.4	15.064
Water, distilled	H2O	0.996	1,498	4,914.7	-2.4	1.00	10.76
Water, heavy	D2O		1,400	4,593			
Water, sea		1.025	1531	5023	-2.4	1.00	10.76

Temperature		Sound Speed in Water	
° C	° F	m/s	ft/s
0	32.0	1402	4600
1	33.8	1407	4616
2	35.6	1412	4633
3	37.4	1417	4649
4	39.2	1421	4662
5	41.0	1426	4679
6	42.8	1430	4692
7	44.6	1434	4705
8	46.4	1439	4721
9	48.2	1443	4734
10	50.0	1447	4748
11	51.8	1451	4761
12	53.6	1455	4774
13	55.4	1458	4784
14	57.2	1462	4797
15	59.0	1465	4807
16	60.8	1469	4820
17	62.6	1472	4830
18	64.4	1476	4843
19	66.2	1479	4853
20	68.0	1482	4862
21	69.8	1485	4872
22	71.6	1488	4882
23	73.4	1491	4892
24	75.2	1493	4899
25	77.0	1496	4908
26	78.8	1499	4918
27	80.6	1501	4925
28	82.4	1504	4935
29	84.2	1506	4941
30	86.0	1509	4951
31	87.8	1511	4958
32	89.6	1513	4964
33	91.4	1515	4971
34	93.2	1517	4977

35	95.0	1519	4984
36	96.8	1521	4984
37	98.6	1523	4990
38	100.4	1525	4997
39	102.2	1527	5010
40	104.0	1528	5013
41	105.8	1530	5020
42	107.6	1532	5026
43	109.4	1534	5033
44	111.2	1535	5036
45	113.0	1536	5040
46	114.8	1538	5046
47	116.6	1538	5049
48	118.4	1540	5053
49	120.2	1541	5056
50	122.0	1543	5063
51	123.8	1543	5063
52	125.6	1544	5066
53	127.4	1545	5069
54	129.2	1546	5072
55	131.0	1547	5076
56	132.8	1548	5079
57	134.6	1548	5079
58	136.4	1548	5079
59	138.2	1550	5086
60	140.0	1550	5086
61	141.8	1551	5089
62	143.6	1552	5092
63	145.4	1552	5092
64	147.2	1553	5092
65	149.0	1553	5095
66	150.8	1553	5095
67	152.6	1554	5099
68	154.4	1554	5099
69	156.2	1554	5099
70	158.0	1554	5099
71	159.8	1554	5099
72	161.6	1555	5102
73	163.4	1555	5102
74	165.2	1555	5102
75	167.0	1555	5102
76	167.0	1555	5102
77	170.6	1554	5099
78	172.4	1554	5099
79	174.2	1554	5099
80	176.0	1554	5099
81	177.8	1554	5099
82	179.6	1553	5095
83	181.4	1553	5095
84	183.2	1553	5095
85	185.0	1552	5092
86	186.8	1552	5092
87	188.6	1552	5092
88	190.4	1551	5089

89	192.2	1551	5089
90	194.0	1550	5086
91	195.8	1549	5082
92	197.6	1549	5082
93	199.4	1548	5079
94	201.2	1547	5076
95	203.0	1547	5076
96	204.8	1546	5072
97	206.6	1545	5069
98	208.4	1544	5066
99	210.2	1543	5063
100	212.0	1543	5063
104	220.0	1538	5046
110	230.0	1532	5026
116	240.0	1524	5000
121	250.0	1516	5007
127	260.0	1507	4944
132	270.0	1497	4912
138	280.0	1487	4879
143	290.0	1476	4843
149	300.0	1465	4807
154	310.0	1453	4767
160	320.0	1440	4725
166	330.0	1426	4679
171	340.0	1412	4633
177	350.0	1398	4587
182	360.0	1383	4538
188	370.0	1368	4488
193	380.0	1353	4439
199	390.0	1337	4387
204	400.0	1320	4331
210	410.0	1302	4272
216	420.0	1283	4210
221	430.0	1264	4147
227	440.0	1244	4082
232	450.0	1220	4003
238	460.0	1200	3937
243	470.0	1180	3872
249	480.0	1160	3806
254	490.0	1140	3740
260	500.0	1110	3642

9 Specification

General

Measuring principle : Ultrasonic time difference correlation principle

Flow velocity range : 0.01 ... 25 m/s

Resolution : 0.25 mm/s

Repeatability : 0.15 % of measured value \pm 0.015 m/s

Accuracy : *Volume flow*

\pm 1 ... 3 % of measured value

depending on application,

\pm 0.5 % of measured value with process calibration

Flow velocity

\pm 0.5 % of measured value

Turn down ratio : 1/100

Gaseous and solid

content of liquid

media : < 10 % of volume

Flowmeter

Enclosure : Hand-held

Degree of

protection : IP 65 according EN 60529

Operating

temperature : -10 ... 60 °C (14 ... 140 °F)

Housing material : ABS (UL 94 HB)

Flow channels : 1

Power supply : Internal rechargeable batteries 4 x NiMH AA 2850 mAh
(daily discharge rate approx. 2% per day, operating range 0-30 deg C)
or external power supply 9 V DC

Operating time : > 24 h with fully charged batteries

Display : LCD graphic display, 128 x 64 dots, backlit

Dimensions : H 228 x W 72/117 x D 47 mm

Weight : Approx. 650 g

Power

consumption : < 10 W

Signal damping : 0 ... 99 s

Measurement rate : 1Hz standard, higher rates on application

Operating

languages : English, German, French, Spanish,

Russian

Response time : 1 s

Quantity and units of measurement

Volumetric flow

rate : m³/h, m³/min, m³/s, l/h, l/min, l/s,

USgal/h (US gallons per hour),

USgal/min, USgal/s, bbl/d (barrels

per day), bbl/h, bbl/min, bbl/s

Flow velocity : m/s, ft/s, inch/s

Mass flow rate : g/s, t/h, kg/h, kg/min

Volume : m³, l, gal (US gallons), bbl

Mass : g, kg, t

Internal data logger

Storage capacity : In excess of 1 million data points (16MB)

Logging data : Up to ten selected variables

Communication

Serial interface : RS 232

Data : Instantaneous measured value,
parameter set and configuration,
logged data

Data+ Software

Functionality : Downloading of measured values/parameter sets, graphical presentation, list format, export to third party software, on-line transfer of measured data

Operating systems : Windows 2000, NT, XP, Vista, 7; Linux; Mac (optional)

10 Index

Acoustic coupling gel	15	Packaging	8
Battery charging	18	Passes	23
Certificate of Conformity	44	Pipe material selection	22
Chains (sensor mounting)	16	Pipe parameters	22
Commissioning	26	Pipe preparation	12
Customer Return Note (CRN)	45	Process value	24
Datalogger	25	Quick Start	22
Diagnostic displays	25	Reflection mode	12
Diagnostics	29	Retaining clip (sensor mounting)	17
Diagonal mode	12	RS 232	29
Dimensions	13	Safety	5
Display	21	Scope function	30
Display icons	21	Sensor configuration	12
Display settings	29	Sensor Location	9
Disturbance sources	10	Sensor mounting	15
Electrical connections	14	Sensor mounting fixtures	16
Error messages	33	Sensor placement screen	24
Fluid selection	23	Sensor Separation	12
Fluid temperature	23	Serial interface	29
Installation	8	Setup Wizard	22
KatData software	29	Sound passes	23
Keypad	19	Specification	41
Keypad function	19	Storage	8
Legislative requirements	6	Switching on / off	18
Liner material	23	Totaliser	25
Maintenance	32	Transit-time method	7
Measurements	24	Troubleshooting	33
Measuring principle	7	Units of measurement	22
Menu structure	26	Wall thickness	23
Negative separation distance	12	Wall thickness measurement	29
Outer Diameter	22	Warranty	6
Output settings	29	Wizard (quick setup)	22

Appendix A

Certificate of Conformity

The USCX200 is manufactured conform CE requirements.

Appendix B



Customer Return Note (CRN)

Company	<input type="text"/>	Address	<input type="text"/>
Name	<input type="text"/>		<input type="text"/>
Tel. No.	<input type="text"/>		<input type="text"/>
E-mail	<input type="text"/>		<input type="text"/>

Instrument model	<input type="text"/>	Arkon contract no. (if	<input type="text"/>
Serial number	<input type="text"/>	known)	
Sensor type(s)	<input type="text"/>		
Sensor serial number(s)	<input type="text"/>		

The enclosed instrument has been used in the following environment (please \surd):

Nuclear radiation	<input type="checkbox"/>
Water-endangering	<input type="checkbox"/>
Toxic	<input type="checkbox"/>
Caustic	<input type="checkbox"/>
Biological	<input type="checkbox"/>
Other (please specify)	<input type="checkbox"/>

We confirm (* delete if not applicable)

- that we have checked the instrument and sensors are free of any contamination*,
- neutralised, flushed and decontaminated all parts which have been in contact with hazardous substances and/or environments*,
- that there is no risk to man or environment through any residual material.

Date	<input type="text"/>
Signature	<input type="text"/>
Company stamp	<input type="text"/>